

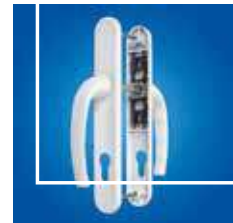

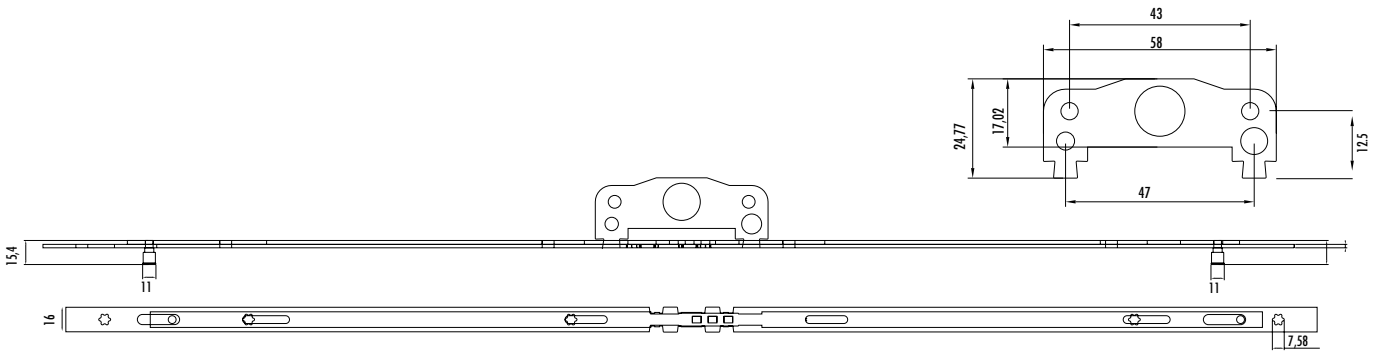

YAPI İNŞAAT SANAYİ VE TİCARET LİMİTED ŞİRKETİ.



Вертикальные Замки Дормас 15





Kod Code	Ürün Adı Product Name Наименование Товара	Ölçüsü (cm) Size (cm) Размер	Koli Adedi Quantity Количество	Ağırlık (Kg) Gross Weight Вес Брутто (кг)	
ISG 01	15 Eksen İspanyolet Espagnolette 15 Axis Вертикальные Замки Дормас 15	30	20	2,90	2
ISG 02	15 Eksen İspanyolet Espagnolette 15 Axis Вертикальные Замки Дормас 15	40	20	3,80	2
ISG 03	15 Eksen İspanyolet Espagnolette 15 Axis Вертикальные Замки Дормас 15	60	20	5,50	2
ISG 04	15 Eksen İspanyolet Espagnolette 15 Axis Вертикальные Замки Дормас 15	80	20	7,25	2
ISG 05	15 Eksen İspanyolet Espagnolette 15 Axis Вертикальные Замки Дормас 15	100	20	9,45	3

Kod Code	Ürün Adı Product Name Наименование Товара	Ölçüsü (cm) Size (cm) Размер	Koli Adedi Quantity Количество	Ağırlık (Kg) Gross Weight Вес Брутто (кг)	
ISG 06	15 Eksen İspanyolet Espagnolette 15 Axis Вертикальные Замки Дормас 15	120	20	10,67	3
ISG 07	15 Eksen İspanyolet Espagnolette 15 Axis Вертикальные Замки Дормас 15	140	20	14,44	4
ISG 08	15 Eksen İspanyolet Espagnolette 15 Axis Вертикальные Замки Дормас 15	160	20	15,22	4
ISG 09	15 Eksen İspanyolet Espagnolette 15 Axis Вертикальные Замки Дормас 15	180	20	15,95	4
ISG 10	15 Eksen İspanyolet Espagnolette 15 Axis Вертикальные Замки Дормас 15	200	20	17,65	4

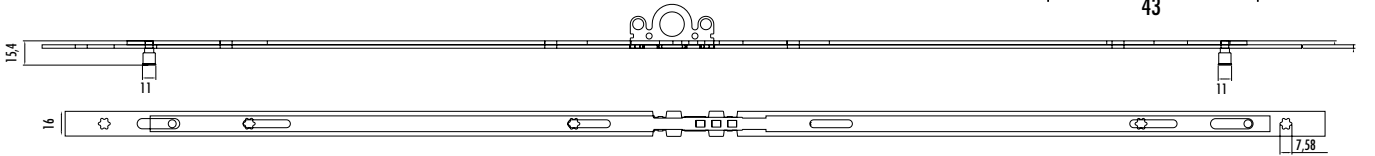
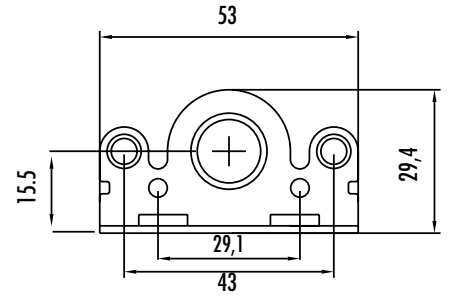
Вертикальные Замки Дормас 15





Kod Code	Ürün Adı Product Name Наименование Товара	Ölçüsü (cm) Size (cm) Размер	Koli Adedi Quantity Количество	Ağırlık (Kg) Gross Weight Вес Брутто	
IZG 01	15 Eksen İspanyolet Espagnolette 15 Axis Вертикальные Замки Дормас 15	30	20	3,25	2
IZG 02	15 Eksen İspanyolet Espagnolette 15 Axis Вертикальные Замки Дормас 15	40	20	4,11	2
IZG 03	15 Eksen İspanyolet Espagnolette 15 Axis Вертикальные Замки Дормас 15	60	20	5,58	2
IZG 04	15 Eksen İspanyolet Espagnolette 15 Axis Вертикальные Замки Дормас 15	80	20	7,00	2
IZG 05	15 Eksen İspanyolet Espagnolette 15 Axis Вертикальные Замки Дормас 15	100	20	8,65	3

Kod Code	Ürün Adı Product Name Наименование Товара	Ölçüsü (cm) Size (cm) Размер	Koli Adedi Quantity Количество	Ağırlık (Kg) Gross Weight Вес Брутто	
IZG 06	15 Eksen İspanyolet Espagnolette 15 Axis Вертикальные Замки Дормас 15	120	20	10,35	3
IZG 07	15 Eksen İspanyolet Espagnolette 15 Axis Вертикальные Замки Дормас 15	140	20	12,43	4
IZG 08	15 Eksen İspanyolet Espagnolette 15 Axis Вертикальные Замки Дормас 15	160	20	14,01	4
IZG 09	15 Eksen İspanyolet Espagnolette 15 Axis Вертикальные Замки Дормас 15	180	20	15,88	4
IZG 10	15 Eksen İspanyolet Espagnolette 15 Axis Вертикальные Замки Дормас 15	200	20	17,79	4

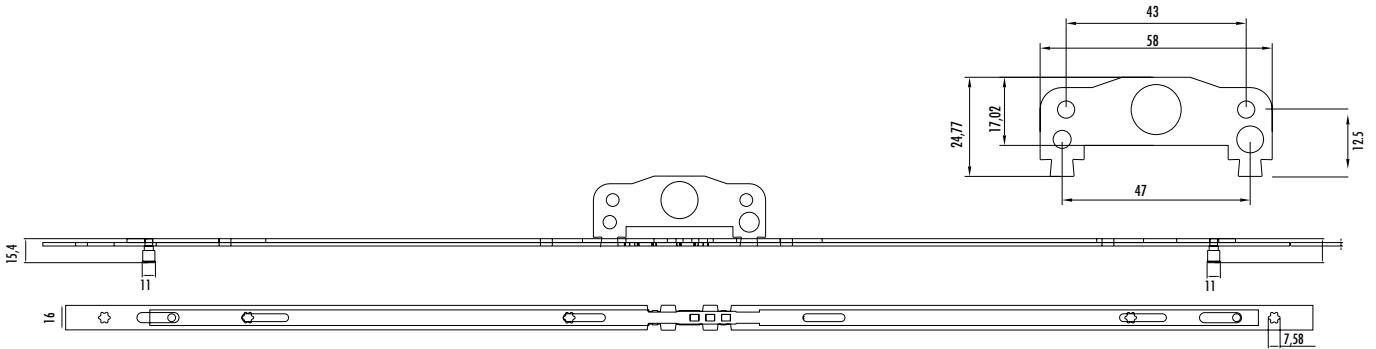
Раздвижные Вертикальные Замки Дормас 15



Kod Code Код	Ürün Adı Product Name Наименование Товара	Ölçüsü (cm) Size (cm) Размер	Koli Adedi Quantity Количество	Ağırlık (Kg) Gross Weight Вес Брутто (Кг)		Kod Code Код	Ürün Adı Product Name Наименование Товара	Ölçüsü (cm) Size (cm) Размер	Koli Adedi Quantity Количество	Ağırlık (Kg) Gross Weight Вес Брутто (Кг)	
ISS 01	15 Eksen Sürme İspanyoletler Sliding Espagnolettes 15 Axis Раздвижные Вертикальные Замки Дормас 15	30	20	3,88	2	ISS 06	15 Eksen Sürme İspanyoletler Sliding Espagnolettes 15 Axis Раздвижные Вертикальные Замки Дормас 15	120	20	10,70	3
ISS 02	15 Eksen Sürme İspanyoletler Sliding Espagnolettes 15 Axis Раздвижные Вертикальные Замки Дормас 15	40	20	4,10	2	ISS 07	15 Eksen Sürme İspanyoletler Sliding Espagnolettes 15 Axis Раздвижные Вертикальные Замки Дормас 15	140	20	12,72	4
ISS 03	15 Eksen Sürme İspanyoletler Sliding Espagnolettes 15 Axis Раздвижные Вертикальные Замки Дормас 15	60	20	5,70	2	ISS 08	15 Eksen Sürme İspanyoletler Sliding Espagnolettes 15 Axis Раздвижные Вертикальные Замки Дормас 15	160	20	14,52	4
ISS 04	15 Eksen Sürme İspanyoletler Sliding Espagnolettes 15 Axis Раздвижные Вертикальные Замки Дормас 15	80	20	7,38	2	ISS 09	15 Eksen Sürme İspanyoletler Sliding Espagnolettes 15 Axis Раздвижные Вертикальные Замки Дормас 15	180	20	16,36	4
ISS 05	15 Eksen Sürme İspanyoletler Sliding Espagnolettes 15 Axis Раздвижные Вертикальные Замки Дормас 15	100	20	8,96	3	ISS 10	15 Eksen Sürme İspanyoletler Sliding Espagnolettes 15 Axis Раздвижные Вертикальные Замки Дормас 15	200	20	17,84	4

Раздвижные Вертикальные Замки Дормас 15

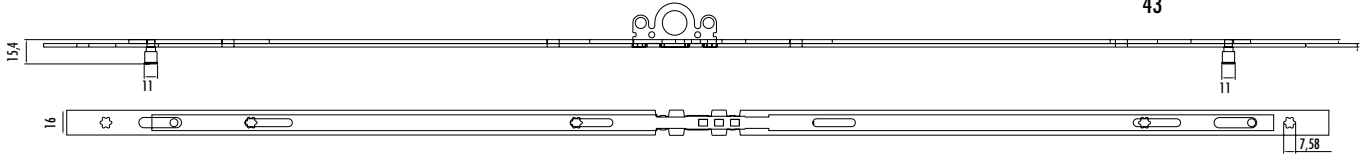
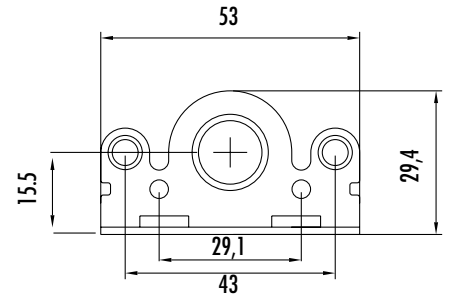

Kod Code	Ürün Adı Product Name Наименование Товара	Ölçüsü (cm) Size (cm)	Koli Adedi Quantity	Ağırlık (Kg) Gross Weight Вес Брутто		Kod Code	Ürün Adı Product Name Наименование Товара	Ölçüsü (cm) Size (cm)	Koli Adedi Quantity	Ağırlık (Kg) Gross Weight Вес Брутто	
ISZ 01	15 Eksen Sürme İspanyoleter Sliding Espagnolettes 15 Axis Раздвижные Вертикальные Замки Дормас 15	30	20	3,20	2	ISZ 06	15 Eksen Sürme İspanyoleter Sliding Espagnolettes 15 Axis Раздвижные Вертикальные Замки Дормас 15	120	20	10,56	3
ISZ 02	15 Eksen Sürme İspanyoleter Sliding Espagnolettes 15 Axis Раздвижные Вертикальные Замки Дормас 15	40	20	4,10	2	ISZ 07	15 Eksen Sürme İspanyoleter Sliding Espagnolettes 15 Axis Раздвижные Вертикальные Замки Дормас 15	140	20	12,72	4
ISZ 03	15 Eksen Sürme İspanyoleter Sliding Espagnolettes 15 Axis Раздвижные Вертикальные Замки Дормас 15	60	20	5,53	2	ISZ 08	15 Eksen Sürme İspanyoleter Sliding Espagnolettes 15 Axis Раздвижные Вертикальные Замки Дормас 15	160	20	14,52	4
ISZ 04	15 Eksen Sürme İspanyoleter Sliding Espagnolettes 15 Axis Раздвижные Вертикальные Замки Дормас 15	80	20	7,25	2	ISZ 09	15 Eksen Sürme İspanyoleter Sliding Espagnolettes 15 Axis Раздвижные Вертикальные Замки Дормас 15	180	20	16,30	4
ISZ 05	15 Eksen Sürme İspanyoleter Sliding Espagnolettes 15 Axis Раздвижные Вертикальные Замки Дормас 15	100	20	8,80	3	ISZ 09	15 Eksen Sürme İspanyoleter Sliding Espagnolettes 15 Axis Раздвижные Вертикальные Замки Дормас 15	200	20	17,84	4

Вертикальные Замки Открывающиеся Наружу и с Системой безопасности



Kod Code Код	Ürün Adı Product Name Наименование Товара	Ölçüsü (cm) Size (cm) Размер	Koli Adedi Quantity Количество	Ağırlık (kg) Gross Weight Вес Брутто (кг)
IGG 01	Geniş Göbek Dışa Açılım İspanyolet 40 eksen Espagnolette Outward Opening Вертикальный Замок (Открывающийся Наружу)	160	20	16,90
IGG 02	Geniş Göbek Dışa Açılım İspanyolet 40 eksen Espagnolette Outward Opening Вертикальный Замок (Открывающийся Наружу)	180	20	18,32
IGG 03	Geniş Göbek Dışa Açılım İspanyolet 40 eksen Espagnolette Outward Opening Вертикальный Замок (Открывающийся Наружу)	200	20	20,10

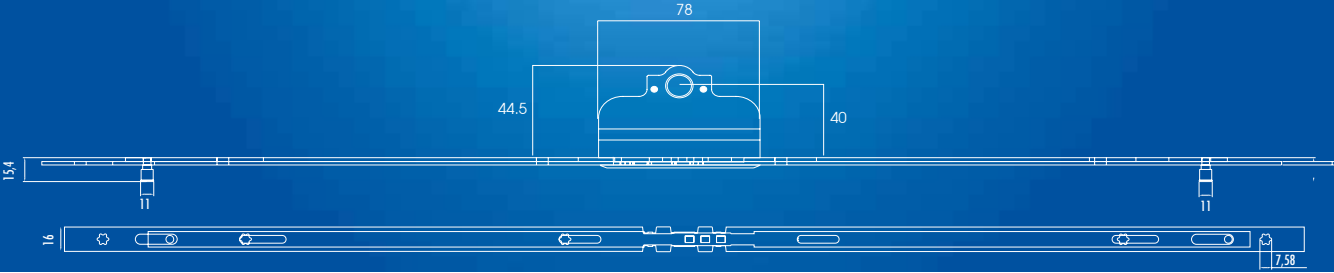



Kod Code Код	Ürün Adı Product Name Наименование Товара	Ölçüsü (cm) Size (cm) Размер	Koli Adedi Quantity Количество	Ağırlık (kg) Gross Weight Вес Брутто (кг)
IGG 04	Geniş Göbek Dışa Açılım İspanyolet 25 eksen Espagnolette Outward Opening Вертикальный Замок (Открывающийся Наружу)	160	25	19,74
IGG 05	Geniş Göbek Dışa Açılım İspanyolet 25 eksen Espagnolette Outward Opening Вертикальный Замок (Открывающийся Наружу)	180	25	21,80
IGG 06	Geniş Göbek Dışa Açılım İspanyolet 25 eksen Espagnolette Outward Opening Вертикальный Замок (Открывающийся Наружу)	200	25	23,17

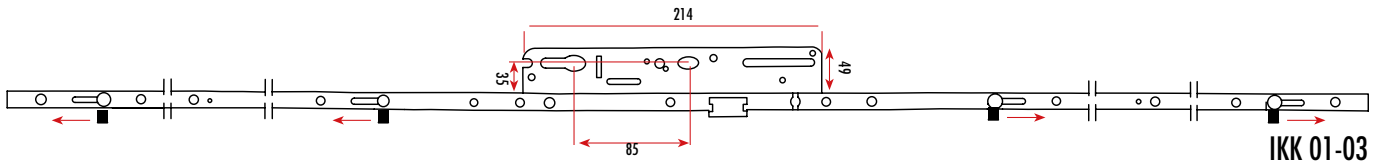

Дверные Вертикальные Замки с Замками

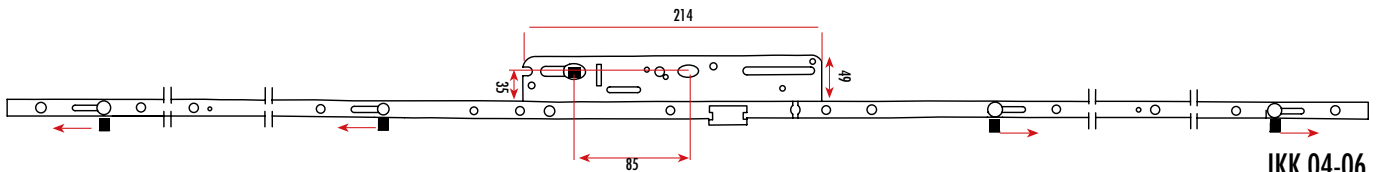

IKK 01-03



IKK 04-06

Kod Code Код	Ürün Adı Product Name Наименование Товара	Ölçüsü (cm) Size (cm) Размер (см)	Koli Adedi Quantity Количество	Ağırlık (Kg) Gross Weight Вес Брутто (кг)
IKK 01	Kilitli Kapı İspanyoleti Espagnolette With Lock for Doors Дверной Вертикальный Замок с Замком	160	20	22,10
IKK 02	Kilitli Kapı İspanyoleti Espagnolette With Lock for Doors Дверной Вертикальный Замок с Замком	180	20	24,00
IKK 03	Kilitli Kapı İspanyoleti Espagnolette With Lock for Doors Дверной Вертикальный Замок с Замком	200	20	25,80

Kod Code Код	Ürün Adı Product Name Наименование Товара	Ölçüsü (cm) Size (cm) Размер (см)	Koli Adedi Quantity Количество	Ağırlık (Kg) Gross Weight Вес Брутто (кг)
IKK 04	Kilitli Kapı İspanyoleti Barelsiz Espagnolette With Lock for Doors Without Cylinder Дверной Вертикальный Замок с Замком Без Ключевины	160	20	22,60
IKK 05	Kilitli Kapı İspanyoleti Barelsiz Espagnolette With Lock for Doors Without Cylinder Дверной Вертикальный Замок с Замком Без Ключевины	180	20	24,30
IKK 06	Kilitli Kapı İspanyoleti Barelsiz Espagnolette With Lock for Doors Without Cylinder Дверной Вертикальный Замок с Замком Без Ключевины	200	20	26,20

Дверные Вертикальные Замки с Замками

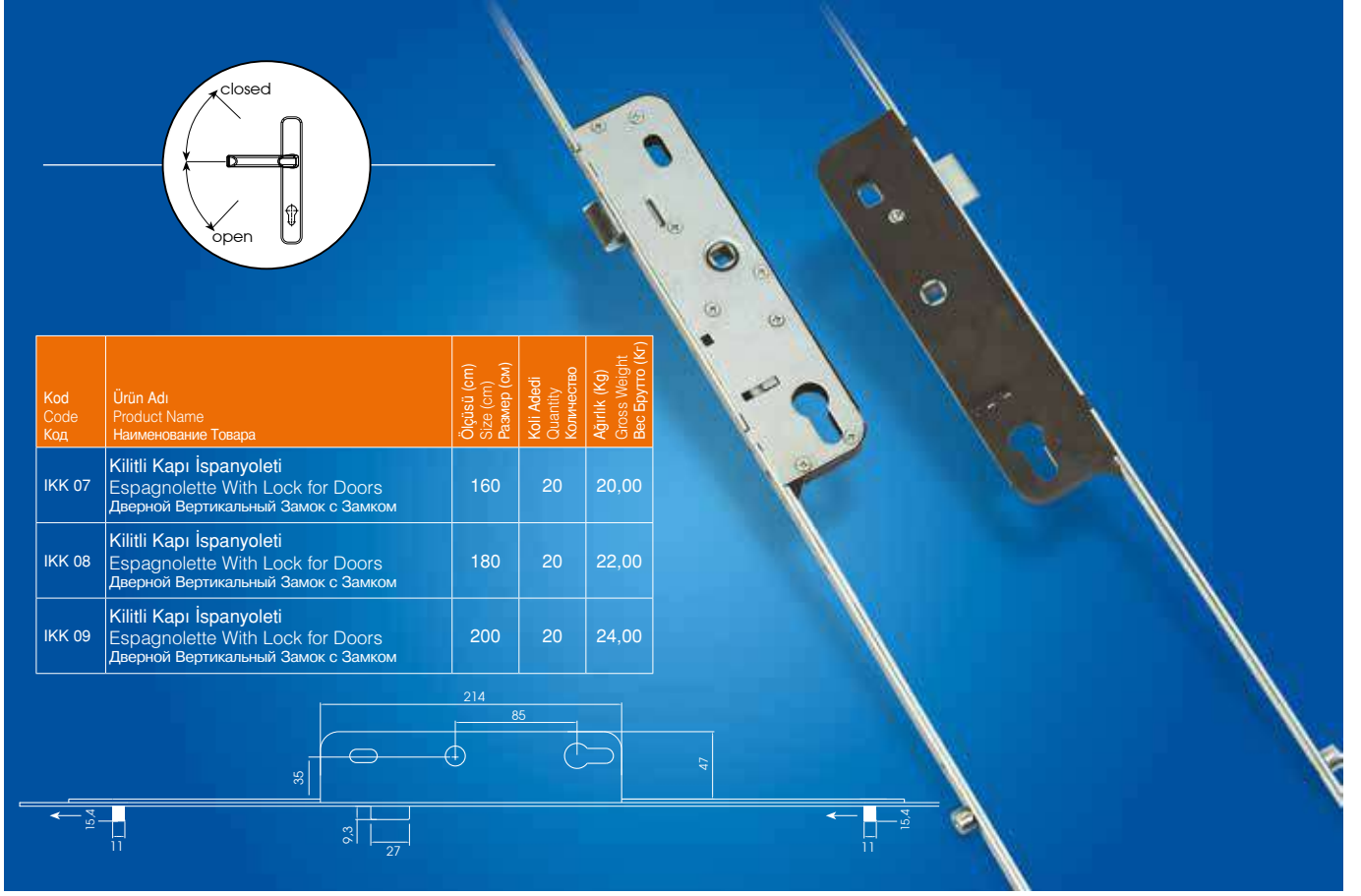

Kod Code Код	Ürün Adı Product Name Наименование Товара	Ölçüsü (cm) Size (cm) Размер (см)	Koli Adedi Quantity Количество	Ağırlık (Kg) Gross Weight Вес Брутто (кг)
IKK 07	Kilitli Kapı İspanyoleti Espagnolette With Lock for Doors Дверной Вертикальный Замок с Замком	160	20	20,00
IKK 08	Kilitli Kapı İspanyoleti Espagnolette With Lock for Doors Дверной Вертикальный Замок с Замком	180	20	22,00
IKK 09	Kilitli Kapı İspanyoleti Espagnolette With Lock for Doors Дверной Вертикальный Замок с Замком	200	20	24,00

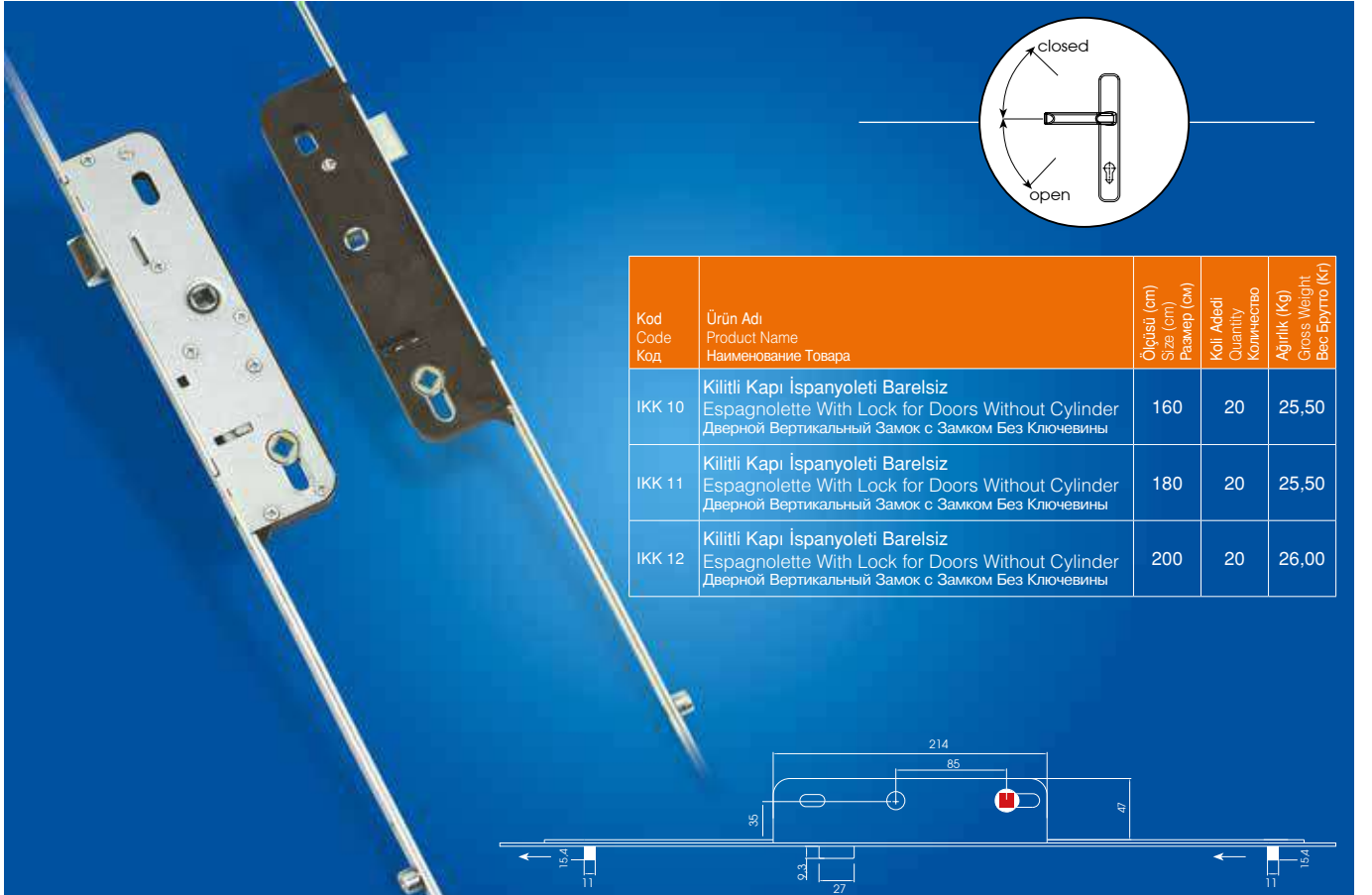

Kod Code Код	Ürün Adı Product Name Наименование Товара	Ölçüsü (cm) Size (cm) Размер (см)	Koli Adedi Quantity Количество	Ağırlık (Kg) Gross Weight Вес Брутто (кг)
IKK 10	Kilitli Kapı İspanyoleti Barelsiz Espagnolette With Lock for Doors Without Cylinder Дверной Вертикальный Замок с Замком Без Ключевини	160	20	25,50
IKK 11	Kilitli Kapı İspanyoleti Barelsiz Espagnolette With Lock for Doors Without Cylinder Дверной Вертикальный Замок с Замком Без Ключевини	180	20	25,50
IKK 12	Kilitli Kapı İspanyoleti Barelsiz Espagnolette With Lock for Doors Without Cylinder Дверной Вертикальный Замок с Замком Без Ключевини	200	20	26,00

Дверные Вертикальные Замки с Замками

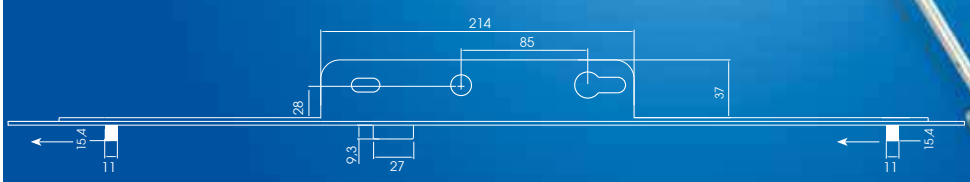

Diagram illustrating the operation of the Espagnolette with Lock for Doors 28 mm. The diagram shows the mechanism in both 'closed' and 'open' positions. The 'closed' position is shown with the handle pointing upwards, and the 'open' position is shown with the handle pointing downwards.

Kod Code Код	Ürün Adı Product Name Наименование Товара	Ölçüsü (cm) Size (cm) Размер (см)	Koli Adedi Quantity Количество	Ağırlık (Kg) Gross Weight Вес Брутто (кг)
IKK 13	Kilitli Kapi İspanyoleti 28 mm Espagnolette With Lock for Doors 28 mm Дверной Вертикальный Замок с Замком 28 мм	160	20	19,00
IKK 14	Kilitli Kapi İspanyoleti 28 mm Espagnolette With Lock for Doors 28 mm Дверной Вертикальный Замок с Замком 28 мм	180	20	20,00
IKK 15	Kilitli Kapi İspanyoleti 28 mm Espagnolette With Lock for Doors 28 mm Дверной Вертикальный Замок с Замком 28 мм	200	20	23,00



Technical drawing showing the dimensions of the Espagnolette with Lock for Doors 28 mm. The drawing includes the following dimensions: 214, 85, 28, 37, 15,4, 9,3, and 27.

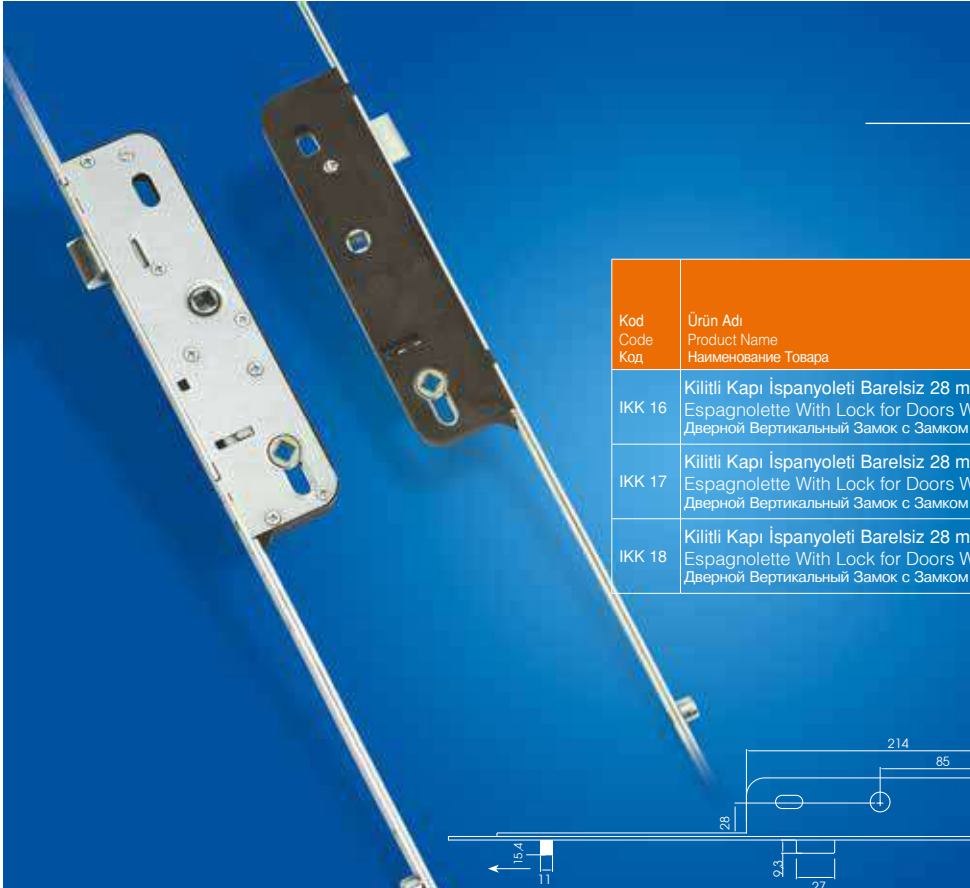
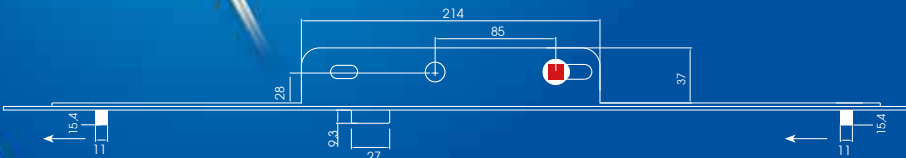
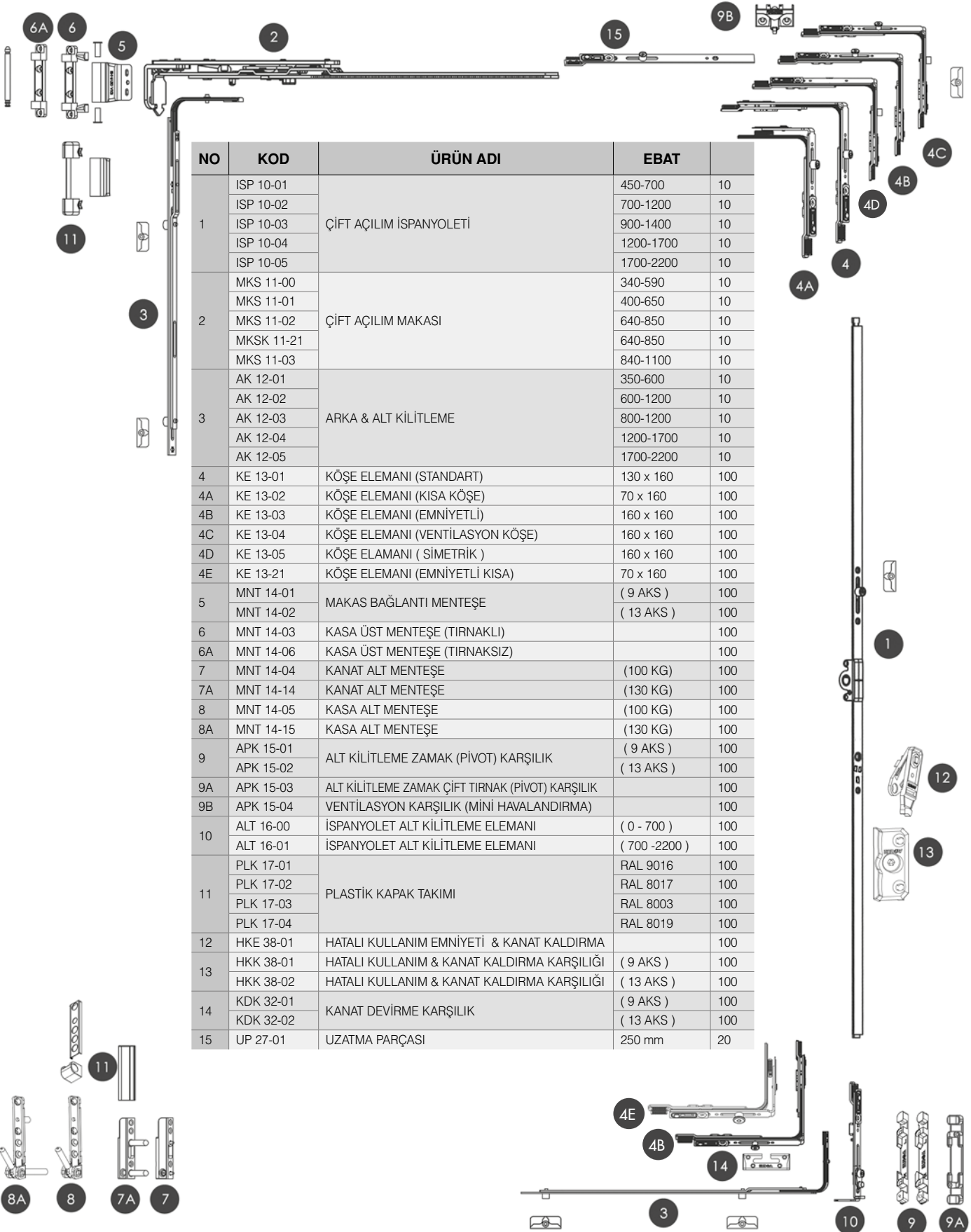

Diagram illustrating the operation of the Espagnolette Without Cylinder 28 mm. The diagram shows the mechanism in both 'closed' and 'open' positions. The 'closed' position is shown with the handle pointing upwards, and the 'open' position is shown with the handle pointing downwards.

Kod Code Код	Ürün Adı Product Name Наименование Товара	Ölçüsü (cm) Size (cm) Размер (см)	Koli Adedi Quantity Количество	Ağırlık (Kg) Gross Weight Вес Брутто (кг)
IKK 16	Kilitli Kapi İspanyoleti Baresiz 28 mm Espagnolette With Lock for Doors Without Cylinder 28 mm Дверной Вертикальный Замок с Замком Без Ключевины 28 мм	160	20	24,00
IKK 17	Kilitli Kapi İspanyoleti Baresiz 28 mm Espagnolette With Lock for Doors Without Cylinder 28 mm Дверной Вертикальный Замок с Замком Без Ключевины 28 мм	180	20	24,00
IKK 18	Kilitli Kapi İspanyoleti Baresiz 28 mm Espagnolette With Lock for Doors Without Cylinder 28 mm Дверной Вертикальный Замок с Замком Без Ключевины 28 мм	200	20	25,00



Technical drawing showing the dimensions of the Espagnolette Without Cylinder 28 mm. The drawing includes the following dimensions: 214, 85, 28, 37, 15,4, 9,3, and 27.



NO	KOD	ÜRÜN ADI	EBAT	
16	GISP 18-1	LEVYE KOLLU GİZLİ İSPANYOLET	510-700	10
	GISP 18-2		700-1200	10
	GISP 18-3		900-1400	10
	GISP 18-4		1200-1700	10
	GISP 18-5		1700-2200	10
17A	SA 19-01	ÇİFT KANAT SÜRGÜ ALT		100
17U	SU 20-01	ÇİFT KANAT SÜRGÜ ÜST		100
18A	LKSA 29-01	MANUEL SÜRGÜ ALT		100
18U	LKSU 30-01	MANUEL SÜRGÜ ÜST		100
19	KOB 26-01	KANAT ORTA BASKI	(9 AKS)	100
	KOB 26-02		(13 AKS)	100
20	GBA 34-01	GİZLİ ORTA BASKI - AYARLI	(9 AKS)	100
	GBA 34-02		(13 AKS)	100
21	TUM 21-01	TEK AÇILIM ÜST MENTEŞE		100
22	TUM 21-02	TEK AÇILIM ORTA MENTEŞE		100
23	TUM 21-03	KÖŞE KANAT ALT MENTEŞE (SAĞ)	(13 AKS)	100
	TUM 21-04		(13 AKS)	100
	TUM 21-05	KÖŞE KANAT ALT MENTEŞE (SOL)	(9 AKS)	100
	TUM 21-06		(9 AKS)	100
24	TUM 21-07	TEK AÇILIM AYARLI ORTA MENTEŞE		100
25	KA 24-01	LEVYE KOL KARŞILIK	(9 AKS)	100
	KA 24-02		(13 AKS)	100
26	KKPLK 28-01	KÖŞE KANAT ALT MENTEŞE PLS. KAPAK TAKIMI	RAL 9016	100
	KKPLK 28-02		RAL 8017	100
	KKPLK 28-03		RAL 8003	100
	KKPLK 28-04		RAL 8019	100
27	TUPLK 31-01	TEK AÇILIM ÜST MENTEŞE PLS. KAPAK TAKIMI	RAL 9016	100
	TUPLK 31-02		RAL 8017	100
	TUPLK 31-03		RAL 8003	100
	TUPLK 31-04		RAL 8019	100
28	KKI 35-160	KİLİTLİ KAPI İSPANYOLETİ (35/85)	160 CM	20
	KKI 35-180		180 CM	20
	KKI 35-200	KİLİTLİ KAPI İSPANYOLETİ (28/85)	200 CM	20
	KKI 28-160		160 CM	20
	KKI 28-180	KİLİTLİ KAPI İSPANYOLETİ (25/85)	180 CM	20
	KKI 28-200		200 CM	20
	KKI 25-160	KİLİTLİ KAPI İSPANYOLETİ (25/85)	160 CM	20
	KKI 25-180		180 CM	20
KKI 25-200		200 CM	20	
29	YSK 10-35	SİLİNDİRLİ KAPI KİLİDİ	35 MM	40
	WCK 20-35	WC KAPI KİLİDİ	35 MM	40
30	TKA 36-01	TEK AÇILIM İSPANYOLETİ (ZAMAK GÖVDE)	30 CM	20
	TKA 36-02		40 CM	20
	TKA 36-03		60 CM	20
	TKA 36-04		80 CM	20
	TKA 36-05		100 CM	20
	TKA 36-06		120 CM	20
	TKA 36-07		140 CM	10
	TKA 36-08		160 CM	10
	TKA 36-09		180 CM	10
	TKA 36-10		200 CM	10
31	TKA 37-01	TEK AÇILIM İSPANYOLETİ (SAC GÖVDE)	30 CM	20
	TKA 37-02		40 CM	20
	TKA 37-03		60 CM	20
	TKA 37-04		80 CM	20
	TKA 37-05		100 CM	20
	TKA 37-06		120 CM	20
	TKA 37-07		140 CM	10
	TKA 37-08		160 CM	10
	TKA 37-09		180 CM	10
	TKA 37-10		200 CM	10
32	BKC 33-01	BALKON KAPI ÇİT ÇİTİ	(9 AKS)	100
	BKC 33-02		(13 AKS)	100
33	VSM 41-01	VASİSTAS MAKAS		100
	VSM 41-02			100



Раздвижные Системы, Раздвижные WOLKSVAGEN, HEBESCHIEBE

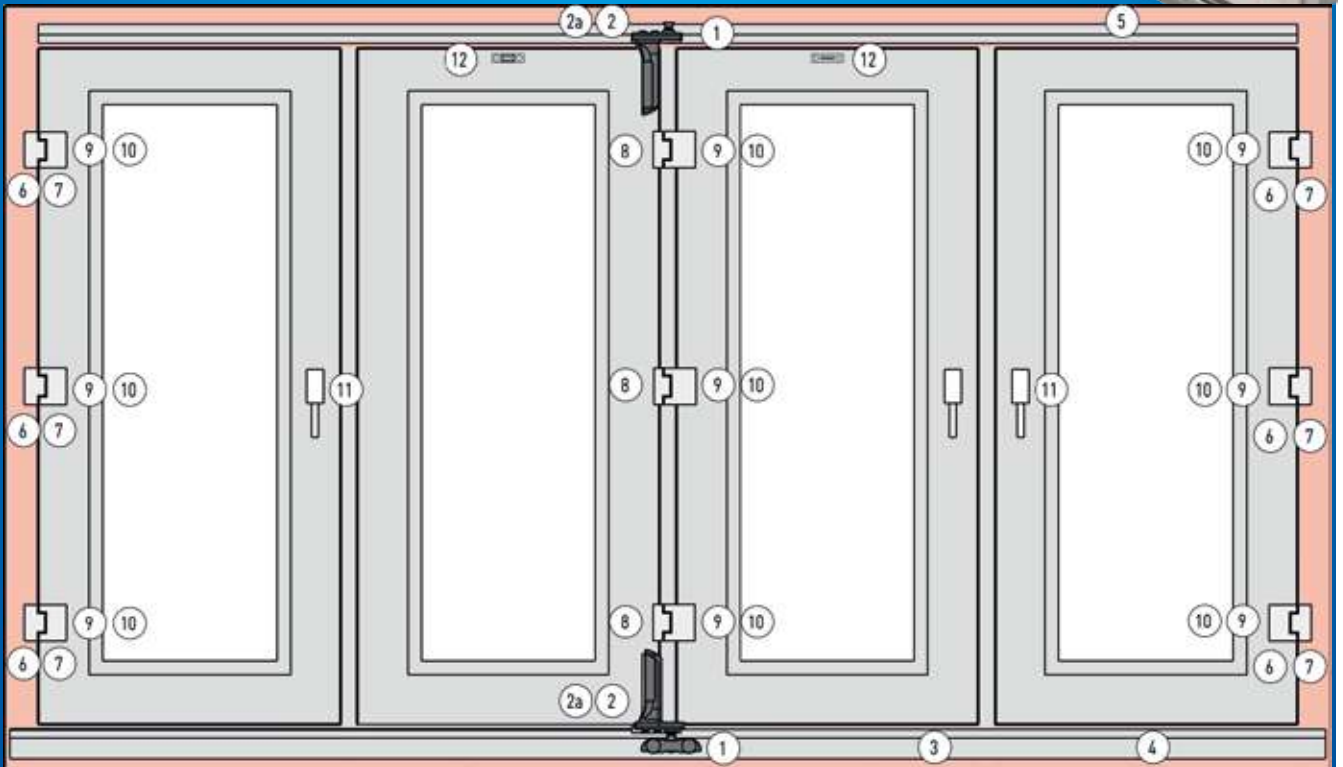

Дверные Замки с Язычком



Kod / Code / Код	S 153 P20	153 P20
Adet / Pcs / ШТ	40	30
Kg / Kg / Кг	12,00	10,13



Kod / Code / Код	S 153 P25	153 P25
Adet / Pcs / ШТ	40	30
Kg / Kg / Кг	12,60	11,24



Kod / Code / Код	S 153 P30	153 P30
Adet / Pcs / ШТ	40	30
Kg / Kg / Кг	13,60	11,80



Kod / Code / Код	S 153 P35	153 P35
Adet / Pcs / ШТ	40	30
Kg / Kg / Кг	14,40	12,02

Дверные Замки Для Ванны и WC



Kod / Code / Код	S 269 P20	269 P20
Adet / Pcs / ШТ	40	40
Kg / Kg / Кг	12,80	13,39



Kod / Code / Код	S 269 P25	269 P25
Adet / Pcs / ШТ	40	40
Kg / Kg / Кг	13	14,66



Kod / Code / Код	S 269 P30	269 P30
Adet / Pcs / ШТ	40	40
Kg / Kg / Кг	14	15,35



Kod / Code / Код	S 269 P35	269 P35
Adet / Pcs / ШТ	40	40
Kg / Kg / Кг	14	16,34

Дверные Замки Роликовые и Комнатные



Kod / Code / Код	S 155 P20	155 P20
Adet / Pcs / ШТ	40	30
Kg / Kg / Кг	11,80	12,17



Kod / Code / Код	S 155 P25	155 P25
Adet / Pcs / ШТ	40	30
Kg / Kg / Кг	12,80	12,33



Kod / Code / Код	S 155 P30	155 P30
Adet / Pcs / ШТ	40	30
Kg / Kg / Кг	13,60	14,02



Kod / Code / Код	S 155 P35	155 P35
Adet / Pcs / ШТ	40	30
Kg / Kg / Кг	15,50	13,92



Kod / Code / Код	S 153 A20	153 20
Adet / Pcs / ШТ	40	30
Kg / Kg / Кг	14,00	13,70



Kod / Code / Код	S 153 A25	153 25
Adet / Pcs / ШТ	40	30
Kg / Kg / Кг	15,00	14,30



Kod / Code / Код	S 153 A30	153 30
Adet / Pcs / ШТ	40	30
Kg / Kg / Кг	16,60	13,40



Kod / Code / Код	S 153 A35	153 35
Adet / Pcs / ШТ	40	30
Kg / Kg / Кг	18,80	12,78

PLASTİK - METAL GÖVDE
ALÜMİNYUM BANYO KAPI KİLİTLERİ

PLASTIC - STEEL BODY
BATH AND WC DOOR LOCKS ALUMINIUM

Алюминиевые Дверные Замки Для Ванны и WC.



Kod / Code / Код	S 269 A20	269 20
Adet / Pcs / ШТ	40	40
Kg / Kg / Кг	13,80	17,96



Kod / Code / Код	S 269 A25	155 25
Adet / Pcs / ШТ	40	40
Kg / Kg / Кг	14,80	18,88



Kod / Code / Код	S 269 A30	269 30
Adet / Pcs / ШТ	40	40
Kg / Kg / Кг	16,10	20,13



Kod / Code / Код	S 269 A35	269 35
Adet / Pcs / ШТ	40	40
Kg / Kg / Кг	18,30	18,26

PLASTİK - METAL GÖVDE ALÜMİNYUM
MAKARALI VE ODA KAPI KİLİTLERİ

Дверные Замки Роликовые и
Комнатные Для Алюминий.

PLASTIC - STEEL BODY DOOR
LOCKS WITH CYLINDER ALUMINIUM



Kod / Code / Код	S 155 A20	155 20
Adet / Pcs / ШТ	40	30
Kg / Kg / Кг	13,20	13,38



Kod / Code / Код	S 155 A25	155 25
Adet / Pcs / ШТ	40	30
Kg / Kg / Кг	14,00	14,15



Kod / Code / Код	S 155 A30	155 30
Adet / Pcs / ШТ	40	30
Kg / Kg / Кг	15,00	14,92



Kod / Code / Код	S 155 A35	155 35
Adet / Pcs / ШТ	40	30
Kg / Kg / Кг	17,90	12,78

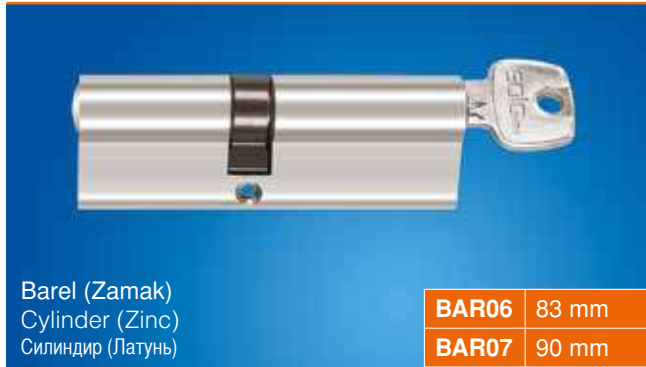
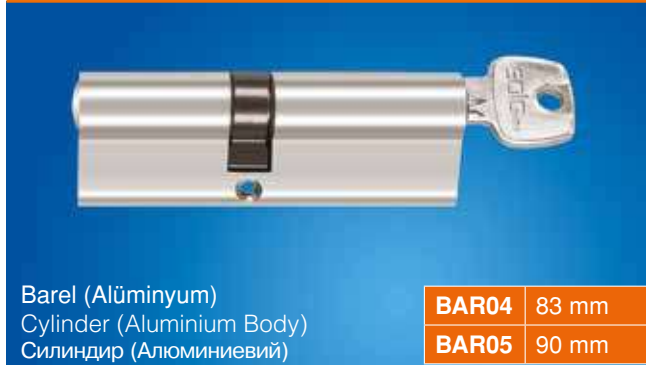

Kod / Code Код	Ürün Adı / Product Name / Наименование Товара	Adet / Pcs шт	Kg Kг
KK 6	Ayarlı Kilit Karşılığı Adjustable Lock Striker Регулируемая Ответная Планка Замка	100	15,00

Kod Code Код	Ambalaj Şekli (Adet) Package Pieces (Pcs) Кол-ва в упак (шт)	Ambalajlı Ağırlık (Kg) Gross Weight (Kg) Вес Брутто (Kг)
BAR 1 68'lik Pirinç Barel	Cylinder 68 mm (Brass Body) Силиндир 68 мм (Латунь)	100 22,00
BAR 2 83'lük Pirinç Barel	Cylinder 83 mm (Brass Body) Силиндир 83 мм (Латунь)	100 27,50
BAR 3 90'lık Pirinç Barel	Cylinder 90 mm (Brass Body) Силиндир 90 мм (Латунь)	100 29,50
BAR 4 83'lük Alüminyum Barel	Cylinder 83 mm (Aluminium Body) Силиндир 83 мм (Алюминиевий)	120 16,00
BAR 5 90'lık Alüminyum Barel	Cylinder 90 mm (Aluminium Body) Силиндир 90 мм (Алюминиевий)	120 17,00
BAR 6 83'lük Zamak Barel	Cylinder 83 mm (Zinc) Силиндир 83 мм (Латунь)	100 19,34
BAR 7 90'lık Zamak Barel	Cylinder 90 mm (Zinc) Силиндир 90 мм (Латунь)	100 20,63
BAR 8 41'lik Topuzlu Barel	WC Cylinder 41 mm Силиндир для ванна 41 мм	12 2,76
BAR 9 68'lik Topuzlu Barel	WC Cylinder 68 mm Силиндир для ванна 68 мм	12 3,56
BAR 10 90'lık Topuzlu Barel	WC Cylinder 90 mm Силиндир для ванна 90 мм	12 5,08

Ответные Планки для Замков

Üniversal Ayarlı Kilit Karşılığı Uzun
Universal Adjustable Lock Striker Long
Универсальная Регулируемая Ответная Планка Замка Длинная



KK 1

Üniversal Ayarlı Kilit Karşılığı Uzun
Universal Adjustable Lock Striker Long
Универсальная Регулируемая Ответная Планка Замка Длинная



KK 3

Üniversal Ayarlı Kilit Karşılığı Kısa
Universal Adjustable Lock Striker Short
Универсальная Регулируемая Ответная Планка Замка Короткая



KK 2

Üniversal Ayarlı Kilit Karşılığı Kısa
Universal Adjustable Lock Striker Short
Универсальная Регулируемая Ответная Планка Замка Короткая



KK 4

PVC & Alüminyum Sürme Kilit
Zinc alloy, Electrostatic white paint



9016	PASK	301 01
8019	PASK	301 02
9005	PASK	301 03
9006	PASK	301 04

PVC & Alüminyum Anahtarlı Sürme Kilit
Zinc alloy, Electrostatic white paint



9016	PAASK	302 01
8019	PAASK	302 02
9005	PAASK	302 03
9006	PAASK	302 04

Balkon Kapı Çitçiti
Balkon Door Stopper
Балконная Защёлка



BKC 1

Ayarlı Kilit Karşılığı ST 1
Adjustable Lock Striker ST 1
Регулируемая Ответная Планка Замка ST 1



KK 5

Kod Code Код	Ambalaj Şekli (Adet) Package Pieces (Pcs) Кол-ва в упак (шт)	Ambalajlı Ağırlık (Kg) Gross Weight (Kg) Вес Брутто (Кг)
KK 1	200	13,20
KK 2	350	13,40
KK 3	250	20,00
KK 4	250	14,60
PASK 301	40	14,50
PAASK 302	40	17,58
KK 5	200	8,6
BKC 1	200	6.60

Цинковые Ответные Планки Вертикального Замка



Kod Code Код	Kullanıldığı Profiller Using Profiles Использование на Следующих Профилях	Kod Code Код	Kullanıldığı Profiller Using Profiles Использование на Следующих Профилях
1	ADOPEN (Tek Delik) - (Rehau -Pimaş)	41	FLORA (Çift Delik)
2	ADOPEN (REHAU-PİMAŞ) EKO (Tek Delik) ***	42	İTERPEN (6.000-7.000 Seri)
3	ADOPEN (Çift Delik)	43	KARPEN (KENDİNDEN CONTALI)
4	ADOPEN V YATAK SÜRME İSP.KARŞ.	44	KMG (Tek Delik)
5	AKAPEN VEGA (Tek Delik) - (Akapen Avantaj)	45	KOMPEN STARLINE (Kom 500) - (Tek Delik)
6	AKAPEN VEGA (Çift Delik)	46	KOMPEN TERMOLINE (Kom 600) - (Çift Delik) ***
7	ALFAPEN ARMADA (Çift Delik)	47	KOMPEN U KAPI (Çift Delik)
8	ALFAPEN (7.000 Seri) - (Çift Delik)	48	KOMPEN SÜPERLINE (Kom 200) - (Çift Delik)
9	A PLAS (Tek Delik)	49	MAESTRO (Tek Delik)
10	A PLAS (Çift Delik)	50	NATUREL (Tek Delik) (Tüm Seriler)
11	ASAŞ 6022 HAYAT K (Kapı) - (Çift Delik)	51	PAKPEN RIVAL - PAKPEN GLOBAL (Çift Delik)
12	ASAŞ 6022 HAYAT P (Pencere) (ASAŞ 5200)- (Çift Delik)	52	PAKPEN - YILDIZ PEN (Tırnaklı) - (Çift Delik)
13	ASAŞ DIAMOND (6.000Seri) Pencere-Kapı (Çift Delik)	53	PAKPEN İDEAL (Çift Delik)
14	ASAŞ 7.000 Seri (7056-7153) (Tek Delik)	54	PENSA (Tek Delik)
15	ASAŞ 7000Seri - (7151-7156) (Çift Delik)	55	PİMAPEN 6.000 (Tek Delik)
16	ARTWIN (Çift Delik)	56	PİMAPEN 6.000 (Çift Delik)
17	BİLKAPEN (Tek Delik)	57	PİMAŞ 4.500 (Tek Delik)
18	ÇAĞLARPEN (Tek Delik)	58	PİMAŞ 4.500 (Çift Delik)
19	ÇİFT KANAT KARŞILIK (Binili Kanat Karş.) (Çift Damak)	59	PENTECH (Tek Delik)
20	ÇİFT KANAT KARŞILIK (Binili Kanat Karş.) (Tek Damak)	60	PLASPEN (Tek Delik)
21	ÇİFT KANAT KARŞILIK (Yaprak Karşılık)	61	PLASWIN (Tek Delik)
22	DURUPEN (Tek Delik)	62	PLASTHERM (Tek Delik)
23	DWT (Tek Delik)	63	PLASTHERM (Çift Delik)
24	EGEPEN ZENDOW (Çift Delik)	64	POLİPEN (Tek Delik)
25	EGEPEN ZENDOW EKONOMİK (Tek Delik)	65	POLİPEN SÜRME (Çift Delik)
26	ERPEN SMARTLINE (Tek Delik)	66	SARAYPEN (Tek Delik)
27	ERPEN SMARTLINE (Çift Delik)	67	SCHÖNLİNE (Line 60 - 70) - (Tek delik)
28	EGEPEN EVEREST (Çift Delik)	68	TAURUSPEN (Tek Delik) (Tüm Seriler)
29	EGEPEN MAX (Çift Delik)	69	TECNOPLAST (Tek Delik)
30	EUROBLOK	70	ÜNİPLAST (Tek Delik)
31	EUROPEN (Tek Delik)	71	YILDIZPEN (Tek Delik)
32	EUROPEN DORLİON (Çift Delik)	72	WINSA DORADO CARINA (Tek Delik)
33	ENDERPEN (Tek Delik)	73	WINAS (Tek Delik)
34	ESENPEN (Tek Delik)	74	WİNDOLİNE (Tek Delik)
35	EUROLİNE (Tek Delik)	75	WİNOPEN (Tek Delik)
36	FIRATPEN (Tek Delik) 9 AKS (İNCE)	76	WİNPLAST (Tek Delik)
37	FIRATPEN (Tek Delik) 13 AKS (KALIN) ***	77	WİNTÜRK (Tek Delik)
38	FIRATPEN (Çift Delik)	78	SÜRME İSPANYOLET KARŞILIĞI
39	FİLPEN (Tek Delik) (Tüm Seriler)	79	ÇİFT KANAT İSPANYOLET KARŞILIĞI
40	FLASPEN (Tek Delik)	80	SAC SÜRME (UNIVERSAL)

Цинковые Крепления Импоста



1	ADOPEN AKDENİZ (İçe Geçen)	53	ERPEN SMARTLINE EKO. (Dar Seri - Symbol)
2	ADOPEN AKDENİZ - (Dışa Geçen)	54	ERPEN SMART ELİT 70/60 (7.000 Seri) O.K.B.T
3	ADOPEN ATLANTİK (Geniş Seri)	55	ERPEN TREND (62 Seri)
4	ADOPEN CRP (PLASWİN)	56	ERPEN EXTRALİNE (54 Seri)
5	ADOPEN MARMARA (6.000 Seri)	57	ERPEN 72 mm GENİŞ (Combine)
6	ADOPEN ATLANTİK (Dar Seri) (4 Odacıklı)	58	ERPEN 72 mm (Combine EKO.DAR PRO.)
7	ADOPEN ATLANTİK (Colorado Seri) (5 Odacıklı)	59	ERPEN 82 mm Multiline
8	ADOPEN YENİ 70 LİK (70/60)	60	ERPEN SÜRME O.K.B.T
9	ADOPEN PASİFİK (8.000 Seri)	61	ERPEN PREMIUM
10	AKAPEN ASTRA (50 mm)	62	EUROLİNE S-60 LÜXE
11	AKAPEN VEGA (58 mm)	63	EUROLİNE E-60 LÜXE
12	AKAPEN VEGA PLUS (58 mm)	64	EUROLİNE S-60 DELUXE
13	AKAPEN MİRA (60 mm 3 odacıklı)	65	EUROLİNE S-70 LÜXE
14	AKAPEN MİRA (60 mm 4 odacıklı)	66	EUROLİNE S-70 DELÜXE
15	ALFAPEN ARMADA	67	EUROPEN BELLA
16	ALFAPEN (ESKİ 7000 Seri) O.K.B.T	68	EUROPEN DORLİON 7.000
17	ALFAPEN (YENİ 7000 Seri) O.K.B.T	69	EUROPEN GRANDE 8.000
18	A PLAS 6030-6040	70	EUROPEN ELİTEX 6.000
19	A PLAS 7050	71	EUROPEN ELİTEX 6.000 (YENİ PROFİL)
20	ASAŞ 5.200 EKO.	72	EUROPEN SÜRME 58'LİK Seri
21	ASAŞ 6.023 HAYAT	73	EUROPEN FİESTA
22	ASAŞ 6.043	74	EUROPEN KHARMA
23	ASAŞ 6.233 HAYAT ECO.	75	EUROPEN LIGHT
24	ASAŞ 6.033 (6.023&6.043)	76	EUROPEN VENTANA
25	ASAŞ 6.143	77	EUROPEN VENTANA 70-60 (OVAL SERİ)
26	ASAŞ 70 (7.056 Seri) Ağır gramaj	78	FIRAT ARAS
27	ASAŞ 70 (7.056 Seri) EKO O.K.B.T	79	FIRATPEN 70/60 EKO O.K.B.T.
28	ASAŞ 7.151 Comfort	80	FIRATPEN 70/60 STANDART O.K.B.T
29	ASAŞ 7.153 Comfort	81	FIRATPEN 70/60 AĞIR GRAMAJ O.K.B.T
30	BAUPLAST 6.000 Seri	82	FIRATPEN (7.000-7.500 Seri) (FIRATPEN KODU 7075)
31	BAUPLAST 7.000 Seri	83	FIRATPEN MİLENYUM (6.000 Seri)
32	DOCDOOR 6.000 Seri	84	FIRATPEN POWER 75 (FIRATPEN KODU 7570)
33	DOCDOOR 7.000 Seri	85	FIRAT S-70 (70/60)
34	DURUPEN (5.800 Seri)	86	FIRAT S-70 (70/60) (EKO PROF.)YENİ SERİ
35	DURUPEN (6.000 Seri)	87	FIRAT SELENİT (YENİ 75) EKO
36	DWT QADRO COMFORT (6.000 Seri)	88	FIRAT SELENİT (YENİ 75) AĞIR GR.
37	DWT QADRO TREND-S (7.000 Seri)	89	FIRATPEN SÜRME (ESKİ SERİ 95'lik)
38	EGEPEN EVEREST EKO.	90	FIRATPEN SÜRME (YENİ SERİ 70'lik)
39	EGEPEN EVEREST	91	FIRATPEN YENİ KAYITLI SÜRME(716) O.K.B.T
40	EGEPEN MAX	92	KARPEN BAYINDIR 6.000
41	EGEPEN MAX (7.000 Seri)	93	KARPEN KALE 7.000
42	EGEPEN ZENDOW O.K.B.T	94	KARPEN YAĞMUR
43	EGEPEN ZENDOW EKONOMİK O.K.B.T	95	KOMPEN PRIMELİNE
44	ENDERPEN CLASLINE (7.000 Seri)	96	KOMPEN (Kom 900)
45	ENDERPEN 7.000 SERİ (YENİ)	97	KOMPEN SÜPERLINE (Kom 200)
46	ENDERPEN ERALİNE	98	KOMPEN STARLINE (Kom 500)
47	ENDERPEN MASTERLINE (5.800 Seri)	99	KOMPEN THERMOLİNE (Kom 600)
48	ENDERPEN MAXLINE	100	KOMPEN THERMOLİNE EKO O.K.B.T
49	ENDERPEN SÜRME	101	MAESTRO S-60
50	ENDERPEN VİZYOLİNE (6.002 Seri)	102	MAESTRO S-70
51	ERPEN SMARTLINE GENİŞ(Classic)(6000)	103	NATUREL NT 6.000 Truva Seri
52	ENDERPEN COMPACTLINE	104	PAKPEN GLOBAL(GENİŞ SERİ)(PROFİL 3930) (6.000 Seri)

Цинковые Крепления Импоста

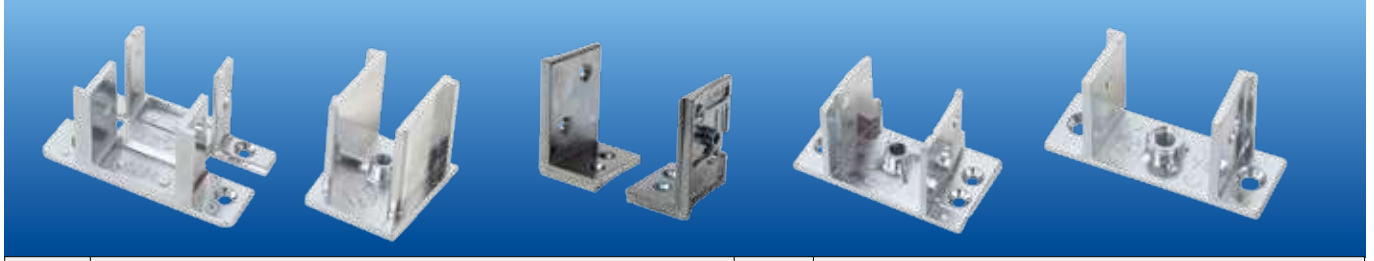

105	PAKPEN GLOBAL DAR SERİ (PROFİL 3931) (6.000 Seri)	155	UNIPLAST 6.000 MONDİAL (4 ODACIK)
106	PAKPEN RİVAL 72 (7.200 Seri)	156	UNIPLAST 7.000 PREMİUM (5 ODACIK)
107	PAKPEN ROYAL 7.000 Seri	157	YILDIZ PEN (5800 Seri)
108	PAKPEN İDEAL 5.800 Seri	158	YILDIZ PEN EFES (6.000 Seri)
109	PENTECH 6.000 SERİ O.K.B.T	159	YILDIZ PEN BORASTAR (7.000 Seri)
110	PENTECH 7.000 SERİ O.K.B.T	160	YILDIZ PEN VİNKİ (6.000 Seri)
111	PİMAPEN S-7.500 FANTASİA	161	YILDIZPEN (3 CONTALI 7.000 SERİ)
112	PİMAPEN S-7.000 HORIZON	162	YILDIZPEN (7.000 SERİ KULAKSIZ)
113	PİMAPEN S-7.000 MAXİMUS	163	YILDIZPEN SMYRNA (6.000 Seri 40dacıklı)
114	PİMAPEN S-6.000 QADRO	164	WINDOLINE O.K.B.T
115	PLASPEN (432 Seri)	165	WINDOLINE (Ağır Gramaj)
116	PLASPEN P- 430 (6.000 Seri)	166	WINDOLINE ULTRA EKO PROF.(6402 SERİ)
117	PLASPEN P- 433 (6.000 Seri)	167	WINDOLINE 6.300 SERİ
118	PLASPEN P- 750 (7.000 Seri)	168	WINDOLINE İNCİ 7.500 SERİ
119	PLASPEN P- 80 (8.000 Seri)	169	WİNSA SAFİR (70 MM Profil)
120	PLASTHERM 6.000 SERİ	170	WİNSA DORADO (76 MM Profil)
121	PLASTHERM 7.000 SERİ	171	WİNSA DORADO GOLD (76 MM Üç Contalı Profil)
122	POLİPEN P- 603 A 30	172	WINOPEN KARDELEN 6.000 SERİ
123	POLİPEN P- 603.E 20	173	WINOPEN NERGİZ 7.0000 SERİ
124	POLİPEN P- 604 A 20	174	WİNTÜRK ALYA 6003
125	POLİPEN P- 70/60 A.20	175	WİNTÜRK ATLAS (6 Odacıklı) 8006
126	POLİPEN P- 705.20	176	WİNTÜRK MİRA 6004
127	POLİPEN P- 806.15	177	WİNTÜRK ORİON 7005
128	POLİPEN SÜRME	178	WORLDPEN (3 Odacıklı)
129	PROPEN Pro.- 60 (6.000 Seri)	179	WORLDPEN YENİ SERİ (4 Odacıklı)
130	PROPEN Pro.- 70 (7.000 Seri)	180	ADVANTECH
131	PROLİNE (Pro 6.004 Seri)	181	BAUFEN 6.000 Seri
132	PROLİNE (Pro 7.000 Seri) - Eko O.K.B.T	182	DİMEK ACCORD
133	PROLİNE (Pro 7.000 Seri) - Ağır Gramaj	183	EURO PVC
134	SARAY 6.000 DAR SERİ	184	GEALİNE
135	SARAY 6.000 GENİŞ SERİ	185	HOLFMAN (İRAN)
136	SARAY 7.000	186	KMG (Bulgar) 3 ODACIKLI DIŞA GEÇEN
137	SCHÖNLİNE (Line 60 Seri)	187	KMG (Bulgar) 4 ODACIKLI İÇE GEÇEN
138	SCHÖNLİNE (Line 70 Seri)	188	KMG (Bulgar) (7000 Seri) (Kasa İçi Dişli) (Setli)
139	SCHÖNLİNE (Linex 60 Seri)	189	KMG (Bulgar) (7000 Seri) (Kanat - Kapı İçi Dişsiz)
140	SCHÖNLİNE (Linex 70 Seri)	190	KÖMMERLİNG İÇE GEÇEN (Eurofutur)
141	SMARTWİN	191	KÖMMERLİNG DIŞA GEÇEN DAR
142	TAURUS BEST	192	PROFİLİNK (Bulgar) (6000 Seri) LUX CLASSIC ULTRA
143	TAURUS BEST EKO. O.K.B.T	193	PROFİLİNK (Bulgar) (7000 Seri) PREMİUM
144	TAURUS ELİT	194	REHAU EURO 70 DAR PROFİL
145	TAURUS GOLD (Sürme)	195	REHAU EURO 86
146	TAURUS PLATİN GENİŞ SERİ	196	SALAMANDER (76'lık Seri)
147	TAURUS PLATİN DAR ECO PROFİL	197	VİVAPLAST(BULGAR) (6.000 SERİ)
148	TAURUS SİLVİER (3 Odacıklı)	198	VİVAPLAST(BULGAR) (7.000 SERİ)
149	TAURUS SİLVİER (4 Odacıklı)	199	VİSTA BEST
150	TAURUS SİLVİER EKO PROFİL	200	VEKA TOPLİNE - SOFTLİNE (7.000 Seri)
151	TECNOPLAS - GROSTEC - EXTRATEC - DIVATEC - MEGATEC	201	WEİSS (BULGAR) (6.000 Seri) (3 Odacıklı)
152	TECNOPLAS STARTECH	202	WEİSS (BULGAR) (6.000 Seri) (3 Odacıklı) YENİ
153	TECNOPLAS ULTRATECH	203	WEİSS (BULGAR) (6.000 Seri) (4 Odacıklı)
154	UNIPLAST 6.000 ECOLİUM (3 ODACIK)	204	WEİSS (BULGAR) (7.000 Seri) Eko.

Дверные и Оконные Шпингалеты

Binili Çift Kanat Sürgü Zamak
Wing Slide With Latch Short
Короткий Створчатый Шпингалет с
Защёлкой



SRG1

Binili Çift Kanat Sürgü Sac
Wing Slide With Latch Long
Длинный Створчатый Шпингалет с
Защёлкой



SRG2

Sac Kapı Sürgü
Wing Slide Short
Короткий Створчатый Шпингалет



SRG3

Sac Kanat Sürgü
Wing Slide Long
Длинный Створчатый Шпингалет



SRG4

Binili Çift Kanat Kısa
Wing Slide Short
Короткий Створчатый Шпингалет



SRG5

Binili Çift Kanat Uzun
Wing Slide Long
Длинный Створчатый Шпингалет



SRG6

Vasistas Makas 13 cm
Vasistas Tilt 13 mm
Ограничитель Фрамуги 13 мм



VSM1

Vasistas Makas 22 cm
Vasistas Tilt 22 mm
Ограничитель Фрамуги 22 мм



VSM2

Çelik Vasistas Makas 22 cm
Vasistas Tilt Steel 22 mm
Металлический Ограничитель
фрамуги стални 22 см



VSM3



9016 8003 8017 8019 9006 9005



9016 8003 8017 8019 9006 9005

Kod Code Код	Koli Adedi Quantity Количество	Ambalajlı Ağırlık (Kg) Gross Weight (Kg) Вес Брутто (Kr)
SRG 1	100	7,30
SRG 2	100	8,90
SRG 3	150	8,40
SRG 4	150	12,90
SRG 5	200	7,20
SRG 6	100	10,00
VSM 1	300	11,30
VSM 2	200	9,30
VSM 3	200	19,50



Замок без Опасности

Plastik Çarpma
Plastic Latch
Пластиковая Защёлка



PC

Alüminyum Çarpma
Aluminium Latch
Алюминивая Защёлка



AC

Emniyet Kilidi
Lock with Security System
Замок без Опасности



EK 1

Emniyet Kilidi
Lock with Security System
Замок без Опасности



EK 4

Emniyet Kilidi
Lock with Security System
Замок без Опасности



EK 3



EK 2

Emniyet Kilidi
Lock with Security System
Замок без Опасности



EK 5

Kod Code Код	Koli Adedi Quantity Количество	Ambalajlı Ağırlık (Kg) Gross Weight (Kg) Вес Брутто (Kg)
PC	250	9,00
AC	500	19,50
EK 1	100	10,00
EK 2	100	10,00
EK 3	100	10,00
EK 4	100	9,80
EK 5	100	13,30

Раздвижные Системы (Ролики)

<p>SUR 1</p> <p>KÜÇÜK SÜRME TEKERLEK (ÜSTÜ KAPALI) SLIDING ROLLER SMALL (IMPLICIT) إنزلاق الأسطوانة الصغيرة (مغلق)</p> 	<p>SUR 6</p> <p>B. ÇİFTLİ SAC TEKERLEK SLIDING ROLLER LARGE (DOUBLE) إنزلاق الأسطوانة الكبيرة (مزدوج)</p> 	<p>SUR 12</p> <p>K. SÜRME TEKERLEK ÜSTÜ AÇIK (PRİNÇ) SLIDING ROLLER SMALL (OPEN TOP) RICE إنزلاق الأسطوانة الصغيرة - مفتوح (برينج)</p> 
<p>SUR 2</p> <p>KÜÇÜK SÜRME TEKERLEK (ÜSTÜ AÇIK) SLIDING ROLLER (OPEN TOP) إنزلاق الأسطوانة الصغيرة (مفتوح)</p> 	<p>SUR 7</p> <p>B.ÇİFTLİ SAC TEKERLEK-KULAKSIZ SLIDING ROLLER LARGE (DOUBLE) دوارة المزدوجة الكبيرة المصفحة - بلا أذان</p> 	<p>SUR 13</p> <p>KÜÇÜK SÜRME TEKERLEK ÜSTÜ KAPALI (PRİNÇ) SLIDING ROLLER SMALL (IMPLICIT) RICE إنزلاق الأسطوانة الصغيرة - مغلق (برينج)</p> 
<p>SUR 3</p> <p>KÜÇÜK SÜRME TEKERLEK (PRİNÇ) SLIDING ROLLER (RICE) إنزلاق الأسطوانة الصغيرة (برينج)</p> 	<p>SUR 8</p> <p>B.ÇİFTLİ SAC TEKER (İTHAL PRİNÇ) SLIDING ROLLER LARGE (DOUBLE) IMPORTED RICE دوارة المزدوجة من الصفائح المعدنية (من الشبكة المستوردة)</p> 	<p>SUR 14</p> <p>PİMAŞ TEKERLEK (PRİNÇ) PIMAS WHEEL (RICE) إنزلاق بيماش (برينج)</p> 
<p>SUR 4</p> <p>EKONOMİK TEKERLEK KANALLI ECONOMIC WHEELS (GROOVE) عجلات الاقتصادية على شكل الأخدود</p> 	<p>SUR 9</p> <p>B.ÇİFTLİ SAC TEK (İTHAL PRİNÇ)-KULAKSIZ SLIDING ROLLER LARGE (DOUBLE) IMPORTED RICE دوارة المزدوجة الكبيرة المصفحة (من الشبكة) "برينج" المستوردة - بلا أذان</p> 	<p>SUR 15</p> <p>TOROS TEKERLEK (WINHOUSE) TOROS WHEELS (WINHOUSE) توروس دوارات (Winhouse)</p> 
<p>SUR 5</p> <p>EKONOMİK TEKERLEK KANALSIZ (DÜZ) ECONOMIC WHEELS STRAIGHT عجلات الاقتصادية المستقيمة</p> 	<p>SUR 11</p> <p>B. ÇİFTLİ SAC TEK.(PRİNÇ) - KULAKSIZ SLIDING ROLLER LARGE (DOUBLE) RICE دوارة المزدوجة الكبيرة المصفحة (برينج : مادة الشبكة) - بلا أذان</p> 	<p>SUR 16</p> <p>TOROS TEKERLEK ÇİFTLİ (WINHOUSE) TOROS WHEELS DOUBLE (WINHOUSE) توروس دوارات مزدوجة (Winhouse)</p> 

Kod Code Код	Koli Adedi Quantity Количество	Ambalajlı Ağırlık (Kg) Gross Weight (Kg) Вес Брутто (Kг)	Kod Code Код	Koli Adedi Quantity Количество	Ambalajlı Ağırlık (Kg) Gross Weight (Kg) Вес Брутто (Kг)
SUR 1	250	13,00	SUR 9	200	24,16
SUR 2	300	13,00	SUR 10	200	24,66
SUR 3	350	17,40	SUR 11	200	24,66
SUR 4	400	16,00	SUR 12	300	14,80
SUR 5	400	16,00	SUR 13	250	14,80
SUR 6	200	23,23	SUR 14	150	12,70
SUR 7	200	23,00	SUR 15	400	15,23
SUR 8	200	24,16	SUR 16	300	15,50

Раздвижные Системы (Ролики)

SUR 17

B. SÜRME TEKERLEK (KAPI)
SLIDING ROLLER LARGE (DOOR)
انزلاق الأسطوانة الكبيرة (الباب)



SUR 22

TEKLİ SAC TEKERLEK
SINGLE WHEEL
عجلة المفردة من الصفائح المعدنية



SUR 27

SİNEKLİK TEKERLEK ERPEN SERİSİ
FLAPPER WHEEL ERPEN SERIES
دوارة الستار من سلسلة "أرپن"



SUR 18

B. SÜRME TEKERLEK (PRİNC)
SLIDING ROLLER LARGE (RICE)
انزلاق الأسطوانة الكبيرة (برینچ)



SUR 23

TEKLİ SAC TEKERLEK (PRİNC)
SINGLE WHEEL RICE
عجلة المفردة من الصفائح المعدنية (من "برینچ")



SUR 28

SİNEKLİK TEKERLEK ASAŞ SERİSİ
ASAŞ FLAPPER WHEEL SERIES
دوارة الستار من سلسلة "آساş"



SUR 19

ÇİFTLİ TEKERLEK ZAMAK (PLASTİK)
SLIDING ROLLER LARGE (DOUBLE)
PLASTIC
انزلاق مزدوج من الزنك (البلاستيك) (Zamak)



SUR 24

TEKLİ SAC TEKERLEK (İTHAL PRİNC)
SINGLE WHEEL IMPORTED RICE
عجلة الفردية من الصفائح المعدنية (من مادة البرینچ المستوردة)



SUR 29

SİNEKLİK TEKERLEK (UNIVERSAL) -
PLASTİK
FLAPPER WHEEL UNIVERSAL PLASTIC
دوارة الستار (يونيفرسال) - من الصفائح المعدنية



SUR 20

ÇİFTLİ TEKERLEK ZAMAK (PRİNC)
SLIDING ROLLER LARGE (DOUBLE)
(RICE)
انزلاق مزدوج من الزنك (برینچ) (Zamak)



SUR 25

TEKLİ SAC TEKERLEK (İTHAL PRİNC) (EKO)
SINGLE WHEEL IMPORTED RICE ECONOMIC
عجلة الفردية من الصفائح المعدنية (من مادة البرینچ المستوردة) (اقتصادي)



SUR 30

SİNEKLİK TEKERLEK (UNIVERSAL) SAC
FLAPPER WHEEL UNIVERSAL IRON
دوارة الستار (يونيفرسال) - البلاستيكي



SUR 21

ÇİFTLİ SAC TEKERLEK KÜÇÜK
COUPLE WITH SMALL WHEEL
دوارة المزدوجة الصغيرة من الصفائح المعدنية



SUR 26

TEKLİ SAC TEKERLEK (EKO)
SINGLE WHEEL ECONOMIC
عجلة الفردية من الصفائح المعدنية (اقتصادي)



SUR 31

KÜÇÜK SÜRME TEKERLEK AYARLI
SMALL SLIDING WHEEL SET
انزلاق الصغير يتم تعديله بالعجلة



Kod Code Код	Koli Adedi Quantity Количество	Ambalajlı Ağırlık (Kg) Gross Weight (Kg) Вес Брутто (Kг)	Kod Code Код	Koli Adedi Quantity Количество	Ambalajlı Ağırlık (Kg) Gross Weight (Kg) Вес Брутто (Kг)
SUR 17	100	14,20	SUR 25	240	16,00
SUR 18	100	16,40	SUR 26	240	20,40
SUR 19	100	14,46	SUR 27	600	10,40
SUR 20	100	17,00	SUR 28	600	10,40
SUR 21	240	16,40	SUR 29	2000	9,40
SUR 22	240	20,40	SUR 30	2000	20,00
SUR 23	240	22,00	SUR 31	240	10,80
SUR 24	240	21,00			



Регулируемые Оконные Дверные Петли

3D Ayarlı Menteşe (Alüminyum / Zamak)
3D Adjustable Hinge (Aluminium / Zinc)
3D Регулируемая Петля (Цинк / Алюминий)



AZM

AAM

Adet / Pcs / шт	24
Kg / Kg / Kг	15,60

Adet / Pcs / шт	24
Kg / Kg / Kг	10,36

Tak Pratik Zamak Menteşe
Practical to instal spiked type



TPM

Adet / Pcs / шт	100
Kg / Kg / Kг	8,00

Alüminyum 'D' Kol
Aluminium 'D' Handle
Алюминиевая Ручка 'Д'



ADK

Adet / Pcs / шт	500
Kg / Kg / Kг	17,50

Alüminyum Gömme Havuz Kol
Aluminium Sliding Handle
Алюминиевая Потайная Ручка



AGK

Adet / Pcs / шт	100
Kg / Kg / Kг	10,40

Alüminyum 'C' Kol
Aluminium 'C' Handle
Алюминиевая Ручка 'C' (Типа Ракушка)



ACK

Adet / Pcs / шт	500
Kg / Kg / Kг	15,30

Plastik Havuz Kol
Plastic Sliding Handle
Пластиковая Потайная Ручка



PHK

Adet / Pcs / шт	1500
Kg / Kg / Kг	16,10

Alüminyum Havuz Kol
Aluminium Sliding Handle
Алюминиевая Потайная Ручка



AHK

Adet / Pcs / шт	100
Kg / Kg / Kг	10,40

Ayarlı (Pipe Menteşe)
Adjustable Hinge (Pipe Hinge)
Регулируемая Петля (Труба Петля)



APM

Adet / Pcs / шт	250
Kg / Kg / Kг	29,50



Группа Петель (Цинковые)



ZM 1

ZM 2

ZM 3

ZM 4

Kod Code Код	Ürün Adı Product Name Наименование Товара	Birim Ağırlığı Unit Weight Вес Единицы	Koli Adedi Quantity Количество	Ağırlık (Kg) Gross Weight Вес Брутто (кг)
ZM 1	75 mm Kanat Menteşe (Zamak) Window Hinge 75 mm (Zinc Alloy) Оконная Петля 75 мм (Цинк)	48 gr	200	13,80
ZM 2	75 mm Kanat Menteşe (Zamak) Window Hinge 75 mm (Zinc Alloy) Оконная Петля 75 мм (Цинк)	52 gr	200	14,60
ZM 3	75 mm Kanat Menteşe (Zamak) Window Hinge 75 mm (Zinc Alloy) Оконная Петля 75 мм (Цинк)	56 gr	200	15,60
ZM 4	75 mm Kanat Menteşe (Zamak) Window Hinge 75 mm (Zinc Alloy) Оконная Петля 75 мм (Цинк)	77 gr	200	19,80



ZM 5

Kod Code Код	Ürün Adı Product Name Наименование Товара	Birim Ağırlığı Unit Weight Вес Единицы	Koli Adedi Quantity Количество	Ağırlık (Kg) Gross Weight Вес Брутто (кг)
ZM 5	90 mm Kapı Menteşe (Zamak) Door Hinge 90 mm (Zinc Alloy) Дверная Петля 90 мм (Цинк)	82 gr	150	16,00



ZM 6

Kod Code Код	Ürün Adı Product Name Наименование Товара	Birim Ağırlığı Unit Weight Вес Единицы	Koli Adedi Quantity Количество	Ağırlık (Kg) Gross Weight Вес Брутто (кг)
ZM 6	95 mm Kapı Menteşe (Zamak) Door Hinge 95 mm (Zinc Alloy) Дверная Петля 95 мм (Цинк)	67 gr	150	13,80



ZM 7

ZM 8

Kod Code Код	Ürün Adı Product Name Наименование Товара	Birim Ağırlığı Unit Weight Вес Единицы	Koli Adedi Quantity Количество	Ağırlık (Kg) Gross Weight Вес Брутто (кг)
ZM 7	100 mm Kapı Menteşe (Zamak) Door Hinge 100 mm (Zinc Alloy) Дверная Петля 100 мм (Цинк)	90 gr	150	17,30
ZM 8	100 mm Kapı Menteşe (Zamak) Door Hinge 100 mm (Zinc Alloy) Дверная Петля 100 мм (Цинк)	112 gr	150	20,80



Алюминиевые Дверные Ручки



SOLO

Kod / Code Код	Ürün Adı / Product Name / Наименование Товара	Adet / Pcs шт	Kg Кг
AKK1	Alüminyum Barelli Kapı Kolu Aluminium Barrel Door Handle Алюминиевая Дверная Ручка	30	11,21



SOLO

Kod / Code Код	Ürün Adı / Product Name / Наименование Товара	Adet / Pcs шт	Kg Кг
AKK2	Alüminyum WC Kapı Kolu Aluminium WC Door Handle Алюм. Дверная Ручка Для Ванной и Туалета	30	11,58



SOLO

Kod / Code Код	Ürün Adı / Product Name / Наименование Товара	Adet / Pcs шт	Kg Кг
AKK3	Alüminyum Oda Kapı Kolu Aluminium Room Handle Алюминиевая Дверная Ручка	30	11,03



SOLO

Kod / Code Код	Ürün Adı / Product Name / Наименование Товара	Adet / Pcs шт	Kg Кг
AKK4	Alüminyum Balkon Kapı Kolu Aluminium Balcony Handle Алюминиевая балкон Ручка	30	11,51



Алюминиевые Дверные Ручки



ALTONA

Kod / Code Код	Ürün Adı / Product Name / Наименование Товара	Adet / Pcs шт	Kg Кг
AKK5	Alüminyum Barelli Kapı Kolu Aluminium Barrel Door Handle Алюминиевая Дверная Ручка	30	12,00



ALTONA

Kod / Code Код	Ürün Adı / Product Name / Наименование Товара	Adet / Pcs шт	Kg Кг
AKK6	Alüminyum WC Kapı Kolu Aluminium WC Door Handle Алюм. Дверная Ручка Для Ванной и Туалета	30	13,60



ALTONA

Kod / Code Код	Ürün Adı / Product Name / Наименование Товара	Adet / Pcs шт	Kg Кг
AKK7	Alüminyum Oda Kapı Kolu Aluminium Room Handle Алюминиевая Дверная Ручка	30	12,20



ALTONA

Kod / Code Код	Ürün Adı / Product Name / Наименование Товара	Adet / Pcs шт	Kg Кг
AKK8	Alüminyum Balkon Kapı Kolu Aluminium Balcony Handle Алюминиевая балкон Ручка	30	14,00



Алюминиевые Дверные Ручки



HAMBURG

Kod / Code Код	Ürün Adı / Product Name / Наименование Товара	Adet / Pcs шт	Kg Кг
AKK9	Alüminyum Barelli Kapı Kolu Aluminium Barrel Door Handle Алюминиевая Дверная Ручка	30	12,00



HAMBURG

Kod / Code Код	Ürün Adı / Product Name / Наименование Товара	Adet / Pcs шт	Kg Кг
AKK10	Alüminyum WC Kapı Kolu Aluminium WC Door Handle Алюм. Дверная Ручка Для Ванной и Туалета	30	13,60



HAMBURG

Kod / Code Код	Ürün Adı / Product Name / Наименование Товара	Adet / Pcs шт	Kg Кг
AKK11	Alüminyum Oda Kapı Kolu Aluminium Room Handle Алюминиевая Дверная Ручка	30	12,20



HAMBURG

Kod / Code Код	Ürün Adı / Product Name / Наименование Товара	Adet / Pcs шт	Kg Кг
AKK12	Alüminyum Balkon Kapı Kolu Aluminium Balcony Handle Алюминиевая балкон Ручка	30	14,00



Алюминиевые Дверные Ручки



TURKUAZ

Kod / Code Код	Ürün Adı / Product Name / Наименование Товара	Adet / Pcs шт	Kg Кг
AKK13	Alüminyum Barelli Kapı Kolu Aluminium Barrel Door Handle Алюминиевая Дверная Ручка	30	13,05



TURKUAZ

Kod / Code Код	Ürün Adı / Product Name / Наименование Товара	Adet / Pcs шт	Kg Кг
AKK14	Alüminyum WC Kapı Kolu Aluminium WC Door Handle Алюм. Дверная Ручка Для Ванной и Туалета	30	14,38



TURKUAZ

Kod / Code Код	Ürün Adı / Product Name / Наименование Товара	Adet / Pcs шт	Kg Кг
AKK15	Alüminyum Oda Kapı Kolu Aluminium Room Handle Алюминиевая Дверная Ручка	30	15,20



TURKUAZ

Kod / Code Код	Ürün Adı / Product Name / Наименование Товара	Adet / Pcs шт	Kg Кг
AKK16	Alüminyum Balkon Kapı Kolu Aluminium Balcony Handle Алюминиевая балкон Ручка	30	15,30



Алюминиевые Дверные Ручки



İBİZA DELUX

Kod / Code Код	Ürün Adı / Product Name / Наименование Товара	Adet / Pcs шт	Kg Кг
AKK17	Alüminyum Barelli Kapı Kolu Aluminium Barrel Door Handle Алюминиевая Дверная Ручка	40	24,74



İBİZA DELUX

Kod / Code Код	Ürün Adı / Product Name / Наименование Товара	Adet / Pcs шт	Kg Кг
AKK18	Alüminyum WC Kapı Kolu Aluminium WC Door Handle Алюм. Дверная Ручка Для Ванной и Туалета	40	13,60



İZMİR DELUX

Kod / Code Код	Ürün Adı / Product Name / Наименование Товара	Adet / Pcs шт	Kg Кг
AKK19	Alüminyum Barelli Kapı Kolu Aluminium Barrel Door Handle Алюминиевая Дверная Ручка	40	19,34



İZMİR DELUX

Kod / Code Код	Ürün Adı / Product Name / Наименование Товара	Adet / Pcs шт	Kg Кг
AKK20	Alüminyum WC Kapı Kolu Aluminium WC Door Handle Алюм. Дверная Ручка Для Ванной и Туалета	40	19,34



Алюминиевые Дверные Ручки



SOLO 26

Kod / Code Код	Ürün Adı / Product Name / Наименование Товара	Adet / Pcs шт	Kg Кг
AKK21	Alüminyum Barelli Kapı Kolu Aluminium Barrel Door Handle Алюминиевая Дверная Ручка	30	11,21



SOLO 30

Kod / Code Код	Ürün Adı / Product Name / Наименование Товара	Adet / Pcs шт	Kg Кг
AKK22	Alüminyum Barelli Kapı Kolu Aluminium Barrel Door Handle Алюминиевая Дверная Ручка	30	11,21



ALTONA 26

Kod / Code Код	Ürün Adı / Product Name / Наименование Товара	Adet / Pcs шт	Kg Кг
AKK23	Alüminyum Barelli Kapı Kolu Aluminium Barrel Door Handle Алюминиевая Дверная Ручка	30	12,00



ALTONA 30

Kod / Code Код	Ürün Adı / Product Name / Наименование Товара	Adet / Pcs шт	Kg Кг
AKK24	Alüminyum Barelli Kapı Kolu Aluminium Barrel Door Handle Алюминиевая Дверная Ручка	30	12,00



Алюминиевые Дверные Ручки



HAMBURG 26

Kod / Code Код	Ürün Adı / Product Name / Наименование Товара	Adet / Pcs шт	Kg Кг
AKK25	Alüminyum Barelli Kapı Kolu Aluminium Barrel Door Handle Алюминиевая Дверная Ручка	30	12,00

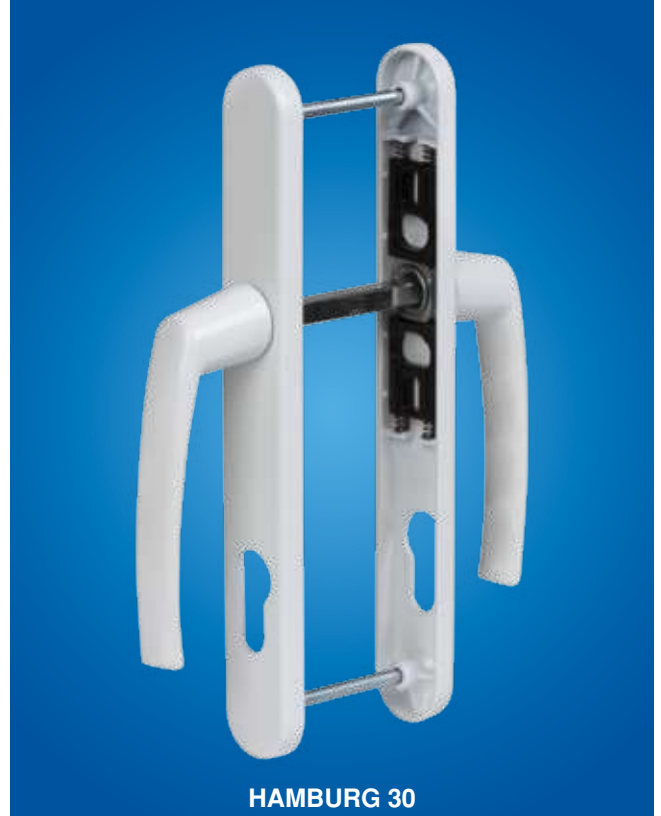

HAMBURG 30

Kod / Code Код	Ürün Adı / Product Name / Наименование Товара	Adet / Pcs шт	Kg Кг
AKK26	Alüminyum Barelli Kapı Kolu Aluminium Barrel Door Handle Алюминиевая Дверная Ручка	30	12,00



TURKUAZ 26

Kod / Code Код	Ürün Adı / Product Name / Наименование Товара	Adet / Pcs шт	Kg Кг
AKK27	Alüminyum Barelli Kapı Kolu Aluminium Barrel Door Handle Алюминиевая Дверная Ручка	40	13,05



NEWYORK

Kod / Code Код	Ürün Adı / Product Name / Наименование Товара	Adet / Pcs шт	Kg Кг
AKK28	Alüminyum Barelli Kapı Kolu Aluminium Barrel Door Handle Алюминиевая Дверная Ручка	30	14,45



TURKUAZ

Kod / Code Код	Ürün Adı / Product Name / Наименование Товара	Adet / Pcs шт	Kg Кг
AKK29	Alm. Kapı Kolu Flat - Turkuaz Alm. Door Handle Flat - Turkuaz Алю. Дверная Ручка Flat - Turkuaz	40	17,42



TURKUAZ

Kod / Code Код	Ürün Adı / Product Name / Наименование Товара	Adet / Pcs шт	Kg Кг
AKK30	Alm. Kapı Kolu Zero - Turkuaz Alm. Door Handle Zero - Turkuaz Алю. Дверная Ручка Zero - Turkuaz	40	17,42



ALTONA

Kod / Code Код	Ürün Adı / Product Name / Наименование Товара	Adet / Pcs шт	Kg Кг
AKK31	Alm. Çekme Kapı Kolu - ALTONA Alm. Pull Door Handle Алю. Ручка Для Дверей		



ALTONA

Kod / Code Код	Ürün Adı / Product Name / Наименование Товара	Adet / Pcs шт	Kg Кг
AKK32	Alm. Tutamaklı D Kapı Kolu - Altona Alm. "D" Door Handle - Altona Алю. "D" Ручка Для Дверей - Altona		



Алюминиевые Оконные Ручки



SOLO

Kod / Code Код	Ürün Adı / Product Name / Наименование Товара	Adet / Pcs шт	Kg Кг
APK1	Alüminyum Pencere Kolu Aluminium Window Handle Алюминиевая Оконная Ручка	100	12,56



ALTONA

Kod / Code Код	Ürün Adı / Product Name / Наименование Товара	Adet / Pcs шт	Kg Кг
APK2	Alüminyum Pencere Kolu Aluminium Window Handle Алюминиевая Оконная Ручка	100	13,80



HAMBURG

Kod / Code Код	Ürün Adı / Product Name / Наименование Товара	Adet / Pcs шт	Kg Кг
APK3	Alüminyum Pencere Kolu Aluminium Window Handle Алюминиевая Оконная Ручка	100	13,80



TURKUAZ

Kod / Code Код	Ürün Adı / Product Name / Наименование Товара	Adet / Pcs шт	Kg Кг
APK4	Alüminyum Pencere Kolu Aluminium Window Handle Алюминиевая Оконная Ручка	100	14,45



AQ

Kod / Code Код	Ürün Adı / Product Name / Наименование Товара	Adet / Pcs шт	Kg Кг
APK5	Alüminyum Pencere Kolu Aluminium Window Handle Алюминиевая Оконная Ручка	100	13,00



İZMİR

Kod / Code Код	Ürün Adı / Product Name / Наименование Товара	Adet / Pcs шт	Kg Кг
APK6	Alüminyum Pencere Kolu Aluminium Window Handle Алюминиевая Оконная Ручка	100	17,20



Алюминиевые Оконные Ручки



Kod / Code Код	Ürün Adı / Product Name / Наименование Товара	Adet / Pcs шт	Kg Кг
APK7	Alüminyum Pencere Kolu Aluminium Window Handle Алюминиевая Оконная Ручка	60	10,83



Kod / Code Код	Ürün Adı / Product Name / Наименование Товара	Adet / Pcs шт	Kg Кг
APK8	Alüminyum Pencere Kolu Aluminium Window Handle Алюминиевая Оконная Ручка	120	23,00



Kod / Code Код	Ürün Adı / Product Name / Наименование Товара	Adet / Pcs шт	Kg Кг
APK9	Alüminyum Pencere Kolu Aluminium Window Handle Алюминиевая Оконная Ручка	100	18,60



Kod / Code Код	Ürün Adı / Product Name / Наименование Товара	Adet / Pcs шт	Kg Кг
APK10	Alüminyum Pencere Kolu Aluminium Window Handle Алюминиевая Оконная Ручка	100	14,00



Kod / Code Код	Ürün Adı / Product Name / Наименование Товара	Adet / Pcs шт	Kg Кг
APK11	Alüminyum Pencere Kolu Aluminium Window Handle Алюминиевая Оконная Ручка	100	16,00



Kod / Code Код	Ürün Adı / Product Name / Наименование Товара	Adet / Pcs шт	Kg Кг
APK12	Alüminyum Pencere Kolu Aluminium Window Handle Алюминиевая Оконная Ручка	100	18,60



Алюминиевые Оконные Ручки



JUMBO IBIZA

Kod / Code Код	Ürün Adı / Product Name / Наименование Товара	Adet / Pcs шт	Kg Кг
APK13	Alüminyum Pencere Kolu Aluminium Window Handle Алюминиевая Оконная Ручка	50	12,55

JUMBO
IBIZA KİLİTLİ

Kod / Code Код	Ürün Adı / Product Name / Наименование Товара	Adet / Pcs шт	Kg Кг
APK14	Alüminyum Pencere Kolu Aluminium Window Handle Алюминиевая Оконная Ручка	50	14,80



MEGA MİLANO

Kod / Code Код	Ürün Adı / Product Name / Наименование Товара	Adet / Pcs шт	Kg Кг
APK15	Alüminyum Pencere Kolu Aluminium Window Handle Алюминиевая Оконная Ручка	50	13,10



JUMBO LARA

Kod / Code Код	Ürün Adı / Product Name / Наименование Товара	Adet / Pcs шт	Kg Кг
APK16	Alüminyum Pencere Kolu Aluminium Window Handle Алюминиевая Оконная Ручка	50	12,70



RİYAD

Kod / Code Код	Ürün Adı / Product Name / Наименование Товара	Adet / Pcs шт	Kg Кг
PPK1	Plastik Pencere Kolu Plastic Window Handle Пластиковая Оконная Ручка	100	10,00



TOKYO

Kod / Code Код	Ürün Adı / Product Name / Наименование Товара	Adet / Pcs шт	Kg Кг
PPK2	Plastik Pencere Kolu Plastic Window Handle Пластиковая Оконная Ручка	100	10,00



Алюминиевые Оконные Ручки



Kod / Code Код	Ürün Adı / Product Name / Наименование Товара	Adet / Pcs шт	Kg Кг
APK17	Alm. Çiftli Kilitli Pencere Kolu Two Side Lockable Window Handle Двухсторонний Запираемая (С Замком) и Открываемая (без Замком) Ручка.	40	19,00



Kod / Code Код	Ürün Adı / Product Name / Наименование Товара	Adet / Pcs шт	Kg Кг
APK19	Alm. Kilitli Pencere Kolu Locable Window Handle Запираемая (С Замком) Ручка Для Окна.	80	21,00



Kod / Code Код	Ürün Adı / Product Name / Наименование Товара	Adet / Pcs шт	Kg Кг
AKK33	Alm. Kilitli Yaylı Mini Set Mini Lock Set with Springed Handle	20	15,15



Kod / Code Код	Ürün Adı / Product Name / Наименование Товара	Adet / Pcs шт	Kg Кг
APK18	Alm. Kapı Pencere Kolu Çift Taraflı Rozetli Alm. Door & Window Handle Double Sided With Rosettes	50	18,40



Kod / Code Код	Ürün Adı / Product Name / Наименование Товара	Adet / Pcs шт	Kg Кг
APK20	Alm. Kapı Pencere Kolu Çift Taraflı Rozetli Alm. Door & Window Handle Double Sided With Rosettes	50	15,05



Kod / Code Код	Ürün Adı / Product Name / Наименование Товара	Adet / Pcs шт	Kg Кг
APK21	Alm. Kapı Pencere Kolu Çift Taraflı Rozetli Alm. Door & Window Handle Double Sided With Rosettes	50	17,00

ALUMİNYUM PENCERE KOLLARI

ALUMINUM WINDOW HANDLES

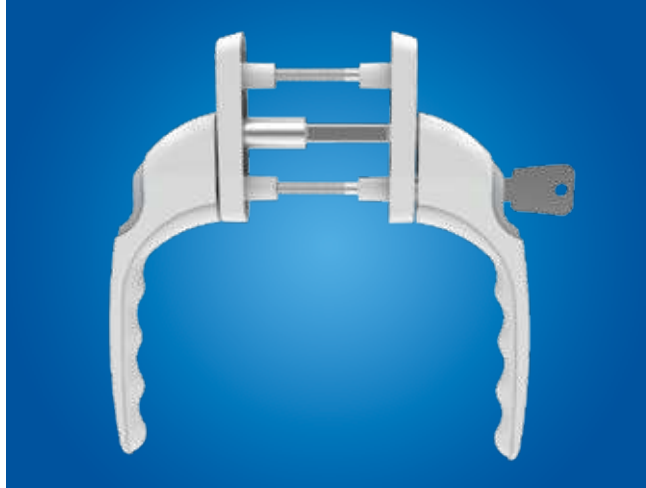

Kod / Code Kod	Ürün Adı / Product Name / Наименование Товара	Adet / Pcs шт	Kg Kг
APK22	Alm. Çiftli Dar Kilitli Pencere Kolu Lockable Window Handle	20	10,50



Kod / Code Kod	Ürün Adı / Product Name / Наименование Товара	Adet / Pcs шт	Kg Kг
APK23	Alm. Dar Kilitli Pencere Kolu Lockable Window Handle	40	10,90



Kod / Code Kod	Ürün Adı / Product Name / Наименование Товара	Adet / Pcs шт	Kg Kг
APK24	Alm. İç Dış Açılır Çiftli Dar Kilitli Pencere Kolu Alm. Lockable Window Handle	16	8,50



Kod / Code Kod	Ürün Adı / Product Name / Наименование Товара	Adet / Pcs шт	Kg Kг
APK25	Alm. İç Dış Açılır Dar Kilitli Pencere Kolu Alm. Lockable Window Handle	32	8,75



Kod / Code Kod	Ürün Adı / Product Name / Наименование Товара	Adet / Pcs шт	Kg Kг
APK26	Alm. Dar Pencere Kolu Alm. Narrow Window Handle	40	9,70



Kod / Code Kod	Ürün Adı / Product Name / Наименование Товара	Adet / Pcs шт	Kg Kг
APK27	Alm. İç Dış Açılır Dar Pencere kolu Inside Outside Opening narrow window handle	32	7,85



ROTLINE
Pencere Kolları

RotoSwing

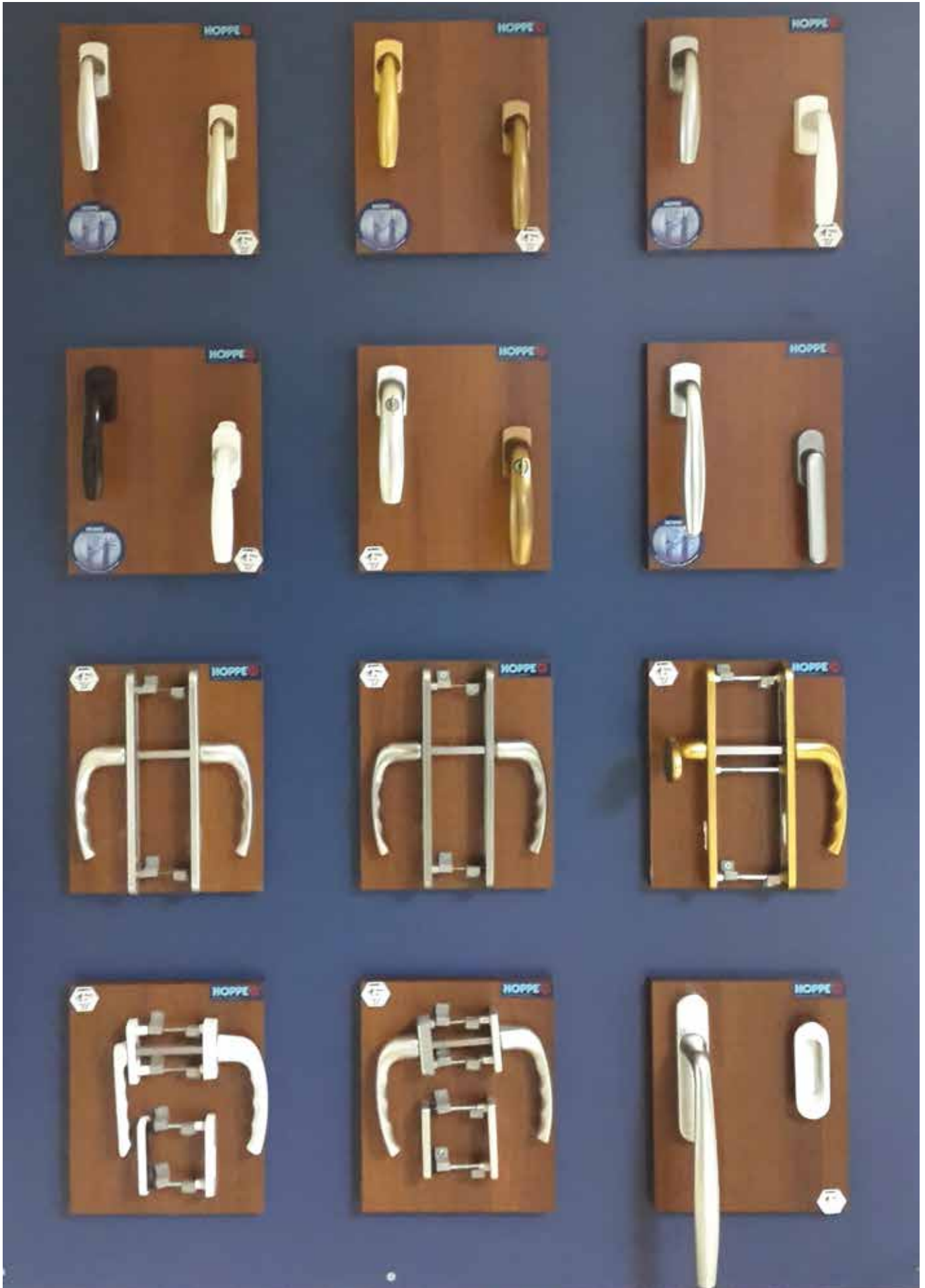

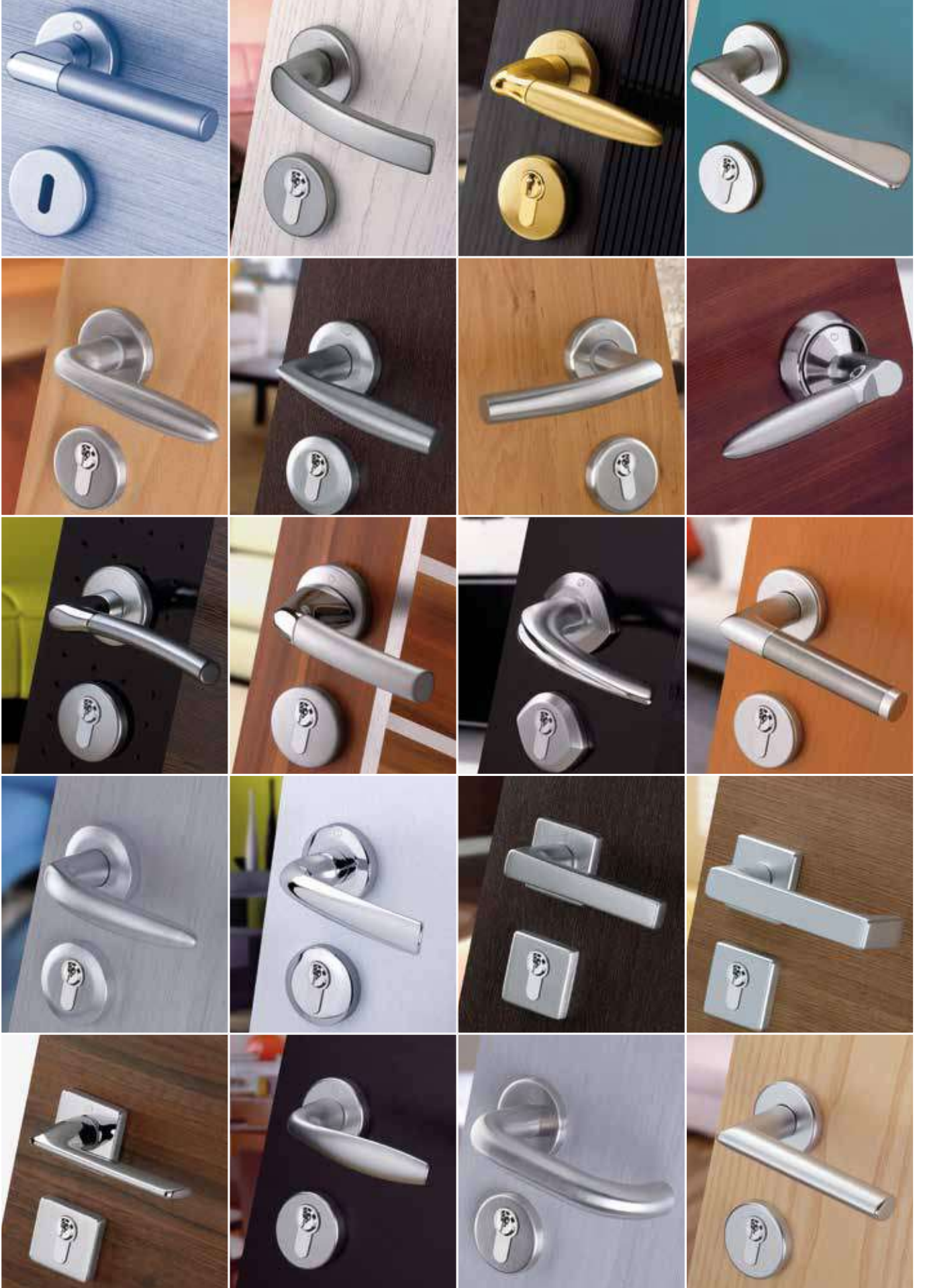

Аксесуары Для Алюминиевые

Kilitli Kol
Lock Handle
Ручки для Балконных Дверей

AA 1



Kilitli Kol
Lock Handle
Ручки для Балконных Дверей

AA 2



İspanyolet Kol - Klasik
Espagnolette Handle - Classic
Ручка для Алюминиевых окон

AA 3



Eksenel Kol - Çift Dilli
Axial Handle - Double Tongue
Ручка Осевая с Двумя Язычками

AA 4



D. Aldoks Binme Mentеше
D. Aldoks Series Hinge
D. Петли для Алюминиевых Окон и Дверей Aldoks

AA 5



F. Aldoks Mentеше
F. Aldoks Series Hinge
F. Петли для Алюминиевых Aldoks

AA 6

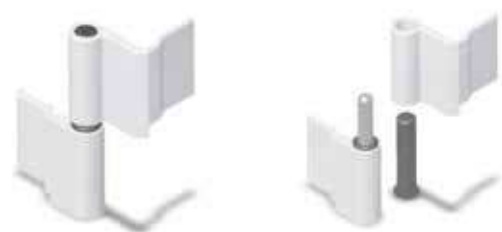

EU Line Mentеше
EU Line Hinge
Петли EU Line

AA 7



EU LINE SÜRGÜ
EU Line Slide
Шпингалет Дверной Наружный на Алюминий

AA 8



Аксессуары Для Алюминиевые

Gömme Sürgü
Sunk Slide
Шпингалет Дверной Врезной на Алюминий

AA 9



Aldoks Kilit Karşığı Dilli - Makaralı
Aldoks Lock Striker With Tongue - Reel
Ответная Планка Дверная

AA 10

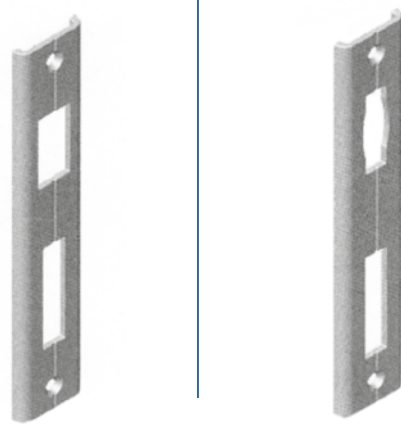

AA 11

Alüminyum Bükme Kıvrık Kol
Aluminium Pipe Handle
Алюминиевая Дугообразная Ручка

AA 12-20



Alüminyum Yarım Ay Kol
Aluminium Half Moon Handle
Алюминиевая Ручка Полумесяц

AA 21-24



Kod Code Код	Ölçü / Size / Размер		Koli Adedi Quantity Количество	Ağırlık (Kg) Gross Weight Вес Брутто (Кг)
	Ø	A		
AA 12	25	20	10	8,90 Kg
AA 13	25	25	10	9,20 Kg
AA 14	25	30	10	9,30 Kg
AA 15	25	35	10	9,60 Kg
AA 16	25	40	10	10,00 Kg
AA 17	30	25	10	9,80 Kg
AA 18	30	30	10	10,00 Kg
AA 19	30	35	10	10,40 Kg
AA 20	30	40	10	10,80 Kg

Kod Code Код	Ölçü / Size / Размер		Koli Adedi Quantity Количество	Ağırlık (Kg) Gross Weight Вес Брутто (Кг)
	Ø	A		
AA 21	25	20	10	8,90 Kg
AA 22	25	30	10	9,20 Kg
AA 23	30	20	10	9,50 Kg
AA 24	30	30	10	10,90 Kg

Подкладки Под Стеклопакеты



Kod Code Код	Ürün Adı Product Name Наименование Товара	Koli Adedi Quantity Количество	Ağırlık (Kg) Gross Weight Вес Брутто (Кг)
CTZ 1	2,5x2 Minik Cam Takozu Glass Wedge - Tiny Подкладка	25,000	12,50
CTZ 2	3,5x2 Küçük Cam Takozu Glass Wedge - Little Подкладка Маленькая	20,000	20,20
CTZ 3	2x20x80 Cam Takozu İnce Glass Wedge Thin Подкладка Тонкая	20,000	38,40
CTZ 4	3x20x80 Cam Tkozu Glass Wedge Подкладка 3 мм	15,000	37,10
CTZ 5	5x20x80 Kalın Cam Takozu Kırılan Glass Wedge Thick Подкладка Толстая	12,000	33,70
CTZ 6	5x20x80 Kalın Cam Takozu Bükülen Glass Wedge Thick Подкладка Толстая	12,000	31,90
CTZ 7	8x4 Tek Cam Takozu Kalın Glass Wedge Thick Подкладка Для Одинорного Стекла Толстая	10,000	15,10
CTZ 8	2x25x80 Cam Takozu İnce Glass Wedge Thin Подкладка Тонкая	15,000	39,10
CTZ 9	3x25x80 Cam Takozu Orta Glass Wedge Medium Подкладка Широкая Средняя	10,000	36,00
CTZ 10	5x25x80 Cam Takozu Kalın Glass Wedge Thick Подкладка Толстая	10,000	44,40
CTZ 11	2x28x80 Cam Takozu İnce Glass Wedge Thin Подкладка Тонкая	15,000	37,40
CTZ 12	3x28x80 Cam Takozu Orta Glass Wedge Medium Подкладка Широкая Средняя	10,000	34,50
CTZ 13	5x28x80 Cam Takozu Kalın Glass Wedge Thick Подкладка Толстая	10,000	42,20
CTZ 14	2x32x80 Cam Takozu İnce Glass Wedge Thin Подкладка Тонкая	10,000	44,20
CTZ 15	3x32x80 Cam Takozu Orta Glass Wedge Medium Подкладка Широкая Средняя	10,000	49,40
CTZ 16	5x32x80 Cam Takozu Kalın Glass Wedge Thick Подкладка Толстая	5,000	33,60



Клипсы и Заглушки

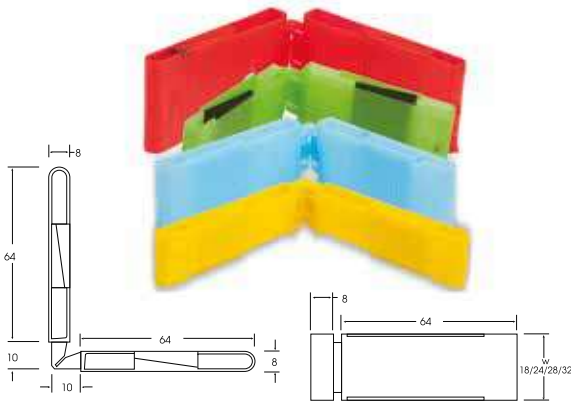

Kod Code Код	Ürün Adı Item Description Наименование Товара	Koli Adedi Quantity Количество	Ağırlık Gross Weight Вес
CTZ 17	Ayarlı Cam Takozu 18 mm Glass Wedge - Tiny Регулируемая Подкладка	500	4,40 KG
CTZ 18	Ayarlı Cam Takozu 24 mm Glass Wedge - Tiny Регулируемая Подкладка	400	4,60 KG
CTZ 19	Ayarlı Cam Takozu 28 mm Glass Wedge - Tiny Регулируемая Подкладка	400	5,50 KG
CTZ 20	Ayarlı Cam Takozu 32 mm Glass Wedge - Tiny Регулируемая Подкладка	400	6,00 KG



Kod Code Код	Ürün Adı Item Description Наименование Товара	Koli Adedi Quantity Количество	Ağırlık Gross Weight Вес
CK 1	Köşe Klipsi 6 mm Corner Clips 6 mm Клипс 6 мм	10.000	7,60 KG
CK 2	Köşe Klipsi 9 mm Corner Clips 9 mm Клипс 9 мм	10.000	13,00 KG
CK 3	Köşe Klipsi 10,5 mm Corner Clips 10,5 mm Клипс 10,5 мм	10.000	16,60 KG
CK 4	Köşe Klipsi 12 mm Corner Clips 12 mm Клипс 12 мм	10.000	18,60 KG
CK 5	Köşe Klipsi 14 mm Corner Clips 14 mm Клипс 14 мм	10.000	23,60 KG
CK 6	Köşe Klipsi 16 mm Corner Clips 16 mm Клипс 16 мм	10.000	26,60 KG

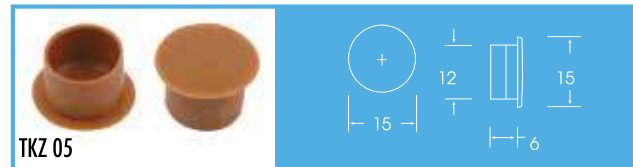
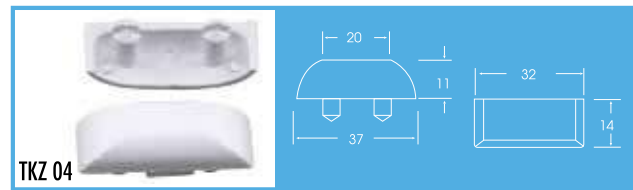
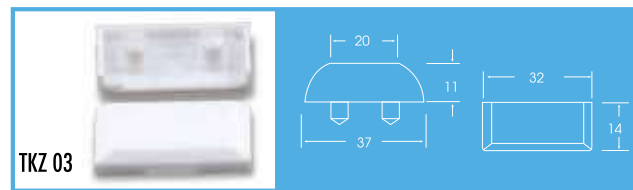
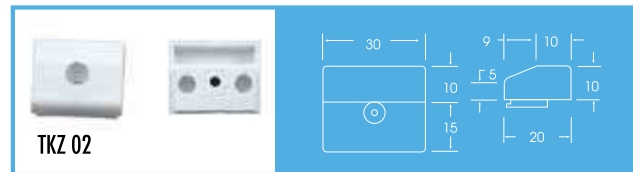
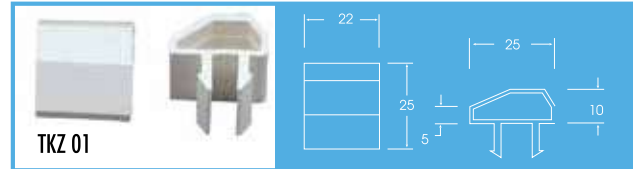

Kod Code Код	Ürün Adı Item Description Наименование Товара	Koli Adedi Quantity Количество	Ağırlık Gross Weight Вес
TKZ.01	Kanat Kaldırma Takozu Sash Lifting Support Подкладка Для Поднимания Створок	10,000	26,60 KG
TKZ.02	Kanat Kaldırma Takozu Vidalı Sash Lifting Support with Screws Подкладка Для Поднимания Створок с Саморезами	10,000	26,60 KG
TKZ.03	Tahliye Tapaşı - Genel Drainage Outlet Cover - General Дренажная Пробка - Обычный	40,000	44,30 KG
TKZ.04	ABS Tahliye Tapaşı ABS Drainage Outlet Cover ABS Дренажная Пробка	25,000	30,90 KG
TKZ 05	Montaj Tapaşı Mounting Plug Монтажная Пробка	30,00	11,20 KG
TKZ 06	Montaj Tapaşı BULDEX Mounting Plug BULDEX Монтажная Пробка BULDEKS	60,000	15,70 KG
TKZ 07	Plastik Dübel 8 mm Kafasız Plastic Dowel 8 mm Headless	15.000	17.00 KG
TKZ 08	Plastik Dübel 8 mm Kafalı Plastic Dowel 8 mm Headed	15.000	17.00 KG
TKZ 09	Plastik Dübel 8 mm Tımalı Plastic Dowel 8 mm Threaded Пластиковый Дюбель	15.000	17.00 KG

Материалы Для Стекла



Kod Code Код	Ürün Adı Product Name Наименование Товара	Koli Adedi Quantity Количество	Ağırlık (Kg) Gross Weight Вес Брутто (Кг)
BCC 1	6 mm Butillli Isıcam Çıtası Glass Spacer Butilized Дистанционная Рамка с Бутилом	1500 m	23,00
BCC 2	9 mm Butillli Isıcam Çıtası Glass Spacer Butilized Дистанционная Рамка с Бутилом	1000 m	17,00
BCC 3	10,5 mm Butillli Isıcam Çıtası Glass Spacer Butilized Дистанционная Рамка с Бутилом	1000 m	18,50
BCC 4	12 mm Butillli Isıcam Çıtası Glass Spacer Butilized Дистанционная Рамка с Бутилом	1000 m	19,50
BCC 5	14 mm Butillli Isıcam Çıtası Glass Spacer Butilized Дистанционная Рамка с Бутилом	750 m	20,00
BCC 6	16 mm Butillli Isıcam Çıtası Glass Spacer Butilized Дистанционная Рамка с Бутилом	750 m	21,60

Kod Code Код	Ürün Adı Product Name Наименование Товара	Ağırlık (Kg) Gross Weight Вес Брутто (Кг)
CMT1	Ekoplast	30 kg + 3 kg
CMT2	Tiakol Тиакол	Katplast 399
CMT3		Ekoplast
CMT4		Katplast 399
CMT5		Katplast 400
CMN1		Nem Alıcı (Silikagel) Molecular Sieve (Slicagel)
CMN2	Molkuлярное Сито (Силикажел)	Molplast
CMN3		Katplast 580

1100 BEST



1101



1102



1202K



1210 WC



1212



1320



6301



1500



2260



2273



2600+2500 BP

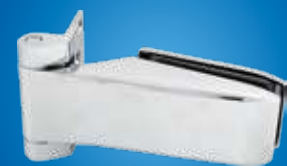

1800



1802



2350



2800 AL



6000



1200



1201



1202



1300



1310 WC



1320+1322



2201



2203



2253



2600



3056



3060



6010



6020



7001



7010



2200





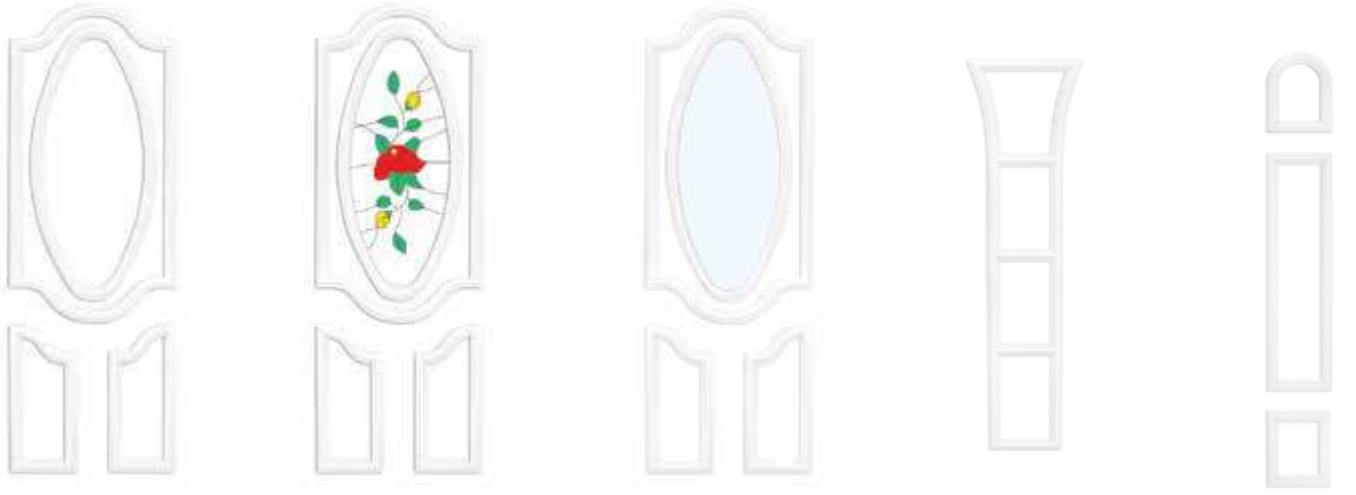



01	Alüminyum Menfez Aluminium Went	35x35
02		35x45
03		40x40
04		40x50
05		45x45
06		45x55
07		45x65
08		65x45
09		50x50
10		55x55
11		55x65
12		65x65



Sürme Sızdırmazlık Takozu
Leake Stoppers



70 mm Hareketli Orta Kayıt Takozu
Mullion Connectors



60 mm Hareketli Orta Kayıt Takozu
Mullion Connectors



Sürme Profil Orta Kayıt Takozu
Million Connector Ties - Plastic



01	Plastik Menfez Sistemleri Plastic Outlet Systems	27x32
02		25x45
03		35x35
04		35x45
05		35x55
06		40x40
07		45x45
08		45x55
09		45x65
10		65x45
11		50x50
12		55x55
13		55x65
14		65x65

Isıcam Havalandırması / Glass ventilation



Isıcam Havalandırması Glass ventilation





Аксессуары Для Москитной Сетки

SIN 01



10x20

SIN 02



Kod Code Код	Ürün Adı Item Description Наименование Товара	Koli Adedi Quantity Количество	Ağırlık Gross Weight Вес	Kod Code Код	Ürün Adı Item Description Наименование Товара	Koli Adedi Quantity Количество	Ağırlık Gross Weight Вес
SIN 01	Sineklik Köşe Takozu 90° Screening Corner Chock 90° Пластиковый Уголок 90°	2000	12 Kg	SIN 02	Sineklik Menteşe Plastik Screening Hinge Plastic Пластиковый Петля Москитной Сетки	2000	20.00 Kg

SIN 03



SIN 04



Kod Code Код	Ürün Adı Item Description Наименование Товара	Koli Adedi Quantity Количество	Ağırlık Gross Weight Вес	Kod Code Код	Ürün Adı Item Description Наименование Товара	Koli Adedi Quantity Количество	Ağırlık Gross Weight Вес
SIN 03	Sineklik Tutma Kolu Screening Handle Пластиковая Ручка	3000	9.00 Kg	SIN 04	Sineklik Çıtçı Screening Lock Пластиковая Защёлка Москитной Сетки	2400	14.40 Kg

SIN 05



SIN 06



Kod Code Код	Ürün Adı Item Description Наименование Товара	Koli Adedi Quantity Количество	Ağırlık Gross Weight Вес	Kod Code Код	Ürün Adı Item Description Наименование Товара	Koli Adedi Quantity Количество	Ağırlık Gross Weight Вес
SIN 05	Sineklik Bağlama Papucu 4'lü Takım Fixed Screening Binder Pad 4 Pcs Пластиковое Крепление Верх - Низ 4 шт	750	7.50 Kg	SIN 06	Sineklik Tutma Halkası Altı Screening Holder Ring Base Держатель Кольца	2500	10.00 Kg

SIN 07



Kod Code Код	Ürün Adı Item Description Наименование Товара	Koli Adedi Quantity Количество	Ağırlık Gross Weight Вес	Kod Code Код	Ürün Adı Item Description Наименование Товара	Koli Adedi Quantity Количество	Ağırlık Gross Weight Вес
SIN 07	Sineklik Tutma Halkası Şeffaf Screening Holder Ring Transparent Прозрачное Кольцо	2500	7.50 Kg	SIN 14	4 mm, 4.5 mm, 5 mm, 6 mm	1000 m	9.50 Kg
SIN 15	Sineklik Fitili						
SIN 16	Screening Wick						
SIN 17	Резина Для Москитной Сетки						



SIN 08



17x25

SIN 09



Kod Code Код	Ürün Adı Item Description Наименование Товара	Koli Adedi Quantity Количество	Ağırlık Gross Weight Вес	Kod Code Код	Ürün Adı Item Description Наименование Товара	Koli Adedi Quantity Количество	Ağırlık Gross Weight Вес
SIN 08	Sineklik Köşe Takozu 90° Screening Corner Chock 90° Пластиковый Уголок 90°	1000	12.00 Kg	SIN 09	Sineklik Menteşe Plastik Screening Hinge Plastic Пластиковый Петля Москитной Сетки	1500	13.75 Kg

SIN 10



SIN 11



Kod Code Код	Ürün Adı Item Description Наименование Товара	Koli Adedi Quantity Количество	Ağırlık Gross Weight Вес	Kod Code Код	Ürün Adı Item Description Наименование Товара	Koli Adedi Quantity Количество	Ağırlık Gross Weight Вес
SIN 10	Sineklik Tutma Kolu Screening Handle Пластиковая Ручка	2500	10.00 Kg	SIN 11	Sineklik Çırtçı Screening Lock Пластиковая Защёлка Москитной Сетки	2000	18.00 Kg

SIN 12



Kod Code Код	Ürün Adı Item Description Наименование Товара	Koli Adedi Quantity Количество	Ağırlık Gross Weight Вес
SIN 12	Sineklik Bağlama Papucu 4'ü Takım Fixed Screening Binder Pad 4 Pcs Пластиковое Крепление Верх - Низ 4 шт	500	5.00 Kg

SIN 13



Kod Code Код	Ürün Adı Item Description Наименование Товара	Koli Adedi Quantity Количество	Ağırlık Gross Weight Вес
SIN 13	Sineklik Tutma Halkası Alın Screening Holder Ring Alın Держатель Кольца	2500	10.00 Kg
SIN 18	Fiberglass Sineklik Tülü Fiberglass Flyscreen Fiberglass Противомоскитная Сетка	96 m	12.00 Kg
SIN 19	80 cm 4 rulo x 30 m	120 m	15.00 Kg
SIN 20	100 cm 4 rulo x 30 m	144 m	18.00 Kg
SIN 21	120 cm 4 rulo x 30 m	168 m	21.00 Kg
SIN 22	140 cm 4 rulo x 30 m	192 m	24.00 Kg
SIN 23	160 cm 4 rulo x 30 m	216 m	27.00 Kg
SIN 24	180 cm 4 rulo x 30 m	240 m	30.00 Kg
SIN 25	200 cm 4 rulo x 30 m	264 m	33.00 Kg
SIN 26	220 cm 4 rulo x 30 m	288 m	36.00 Kg

Уплотнитель Для Раздвижных Систем



PB 48-450	Panjur Fitili / Pile Weather Strip / Затворные Уплотнители	2200 mt/koli
PB 48-500	Panjur Fitili / Pile Weather Strip / Затворные Уплотнители	2000 mt/koli
PB 48-800	Panjur Fitili / Pile Weather Strip / Затворные Уплотнители	1100 mt/koli
PB 48-1000	Panjur Fitili / Pile Weather Strip / Затворные Уплотнители	1000 mt/koli
PB 48-1500	Panjur Fitili / Pile Weather Strip / Затворные Уплотнители	250 mt/koli

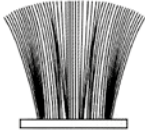

PB 67-550	Panjur Fitili / Pile Weather Strip / Затворные Уплотнители	1400 mt/koli
PB 67-600	Panjur Fitili / Pile Weather Strip / Затворные Уплотнители	1300 mt/koli
PB 67-650	Panjur Fitili / Pile Weather Strip / Затворные Уплотнители	1100 mt/koli
PB 67-700	Panjur Fitili / Pile Weather Strip / Затворные Уплотнители	1100 mt/koli
PB 67-800	Panjur Fitili / Pile Weather Strip / Затворные Уплотнители	900 mt/koli
PB 67-1000	Panjur Fitili / Pile Weather Strip / Затворные Уплотнители	500 mt/koli
PB 67-1500	Panjur Fitili / Pile Weather Strip / Затворные Уплотнители	250 mt/koli

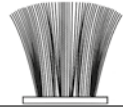

HM 67-800	Yapışkanlı Fitil / Seal With Adhesive / Уплотнитель С Клейком	600 mt/koli
-----------	---	-------------



CF 48-650	Sürme Fitili / Brush Seal For Sliding / Уплотнители Раздвижных Систем	1300 mt/koli
CF 48-800	Sürme Fitili / Brush Seal For Sliding / Уплотнители Раздвижных Систем	800 mt/koli
CF 54-650	Sürme Fitili / Brush Seal For Sliding / Уплотнители Раздвижных Систем	1300 mt/koli
CF 51-800	Sürme Fitili / Brush Seal For Sliding / Уплотнители Раздвижных Систем	800 mt/koli
CF 60-575	Sürme Fitili / Brush Seal For Sliding / Уплотнители Раздвижных Систем	1000 mt/koli
CF 67-550	Sürme Fitili / Brush Seal For Sliding / Уплотнители Раздвижных Систем	1300 mt/koli
CF 67-1100	Sürme Fitili / Brush Seal For Sliding / Уплотнители Раздвижных Систем	500 mt/koli
CF 69-700	Sürme Fitili / Brush Seal For Sliding / Уплотнители Раздвижных Систем	900 mt/koli
CF 72-800	Sürme Fitili / Brush Seal For Sliding / Уплотнители Раздвижных Систем	700 mt/koli
CF 75-700	Sürme Fitili / Brush Seal For Sliding / Уплотнители Раздвижных Систем	900 mt/koli

ALÜMİNYUM KAPI ALTI FIRÇALARI / BRUSH WIND BLOCKERS / Уплотнители Для Алюминиевых Дверей



Kod Code Код	Ürün Adı Item Description Наименование Товара	Koli Adedi Quantity Количество	Kod Code Код	Ürün Adı Item Description Наименование Товара	Koli Adedi Quantity Количество
2017D	Kapı Altı Firçası (Düz) Dust Wick (Plain) Уплотнители Для Алюминиевых Дверей	100	2017T	T Kapı Altı Firçası Dust Wick Уплотнители Для Алюминиевых Дверей (Т)	100



ABC 100
ACRYLIC
SEALANT



ABC 116
TILE
GROUT



ABC 117
READY TO
REPAIR
PUTTY



ABC 112
ULTRA LIGHT
SEALANT



ABC 115
INDICATOR
PINK
SEALANT



ABC 150
PREMIUM
SILCONED
SEALANT



ABC 200
PREMIUM
SILCONED
SEALANT



ABC 300
EXTRA
SILCONED
SEALANT



ABC 344
DUCT
SEALANT



ABC 400
EXTERIOR
SEALANT
(ran res stan e)



ABC 500
PERFORMANCE
SEALANT
(ran res stan e)



ABC 1000
MAXIMUM
SEALANT



ABC 650
FIRESTOP
SEALANT



ABC 600
CONTRACTORS
UNIVERSAL
SILICONE



ABC 800
CONTRACTORS
UNIVERSAL
SILICONE



ABC 900
CONTRACTORS
UNIVERSAL
SILICONE



ABC 750
HIGH TEMP.
SILICONE



ABC 777
SHOWER &
CABINET
SILICONE



ABC 870
MIRROR
SILICONE



ABC 950
NEUTRAL
EATHER SEAL
SILCONES



ABC HOTMELT
STICK
SILICONE
GLUE



ABC 990
AQUARIUM
SILICONE



ABC TUBE
CONTRACTORS
UNIVERSAL
SILICONE



ABC TUBE
RTV HIGH
TEMPERATURE
GASKET SILICONE



ABC 915
POLYURETHANE
SEALANT
CONSTRUCTION



ABC 920
POLYURETHANE
SEALANT
(AUTOMOTIVE)



ABC 930
POLYURETHANE
SEALANT
(WINDSHIELD)



ABC 2000
MAXIMUM
SEALANT



ABC 555
HYBRID
SEALANT



ABC 111
ROOF AND
GUTTER SEALANT



ABC 222
BALCONY SYSTEM
SILICONE



ABC B2
FIRE
RETARDENT
PU FOAM



ABC 808
FOAM CLEANER



ABC 840
FILL & FIX
POLYURETHANE
FOAM



ABC 860
FILL & FIX
POLYURETHANE
FOAM



ABC 880
FILL & FIX
POLYURETHANE
FOAM GUN TYPE



ABC 910
FILL & FIX ADHESIVE
POLYURETHANE
FOAM



ABC 940
FILL & FIX
WINDOW AND
DOOR PU FOAM



ABC 950
FILL & FIX
MEGA PU FOAM
(70LT)



ABC 970
FILL & FIX
SAFETY VALVE
PU FOAM



ABC B1
FIRE
RETARDENT
PU FOAM

Саморезы



YHB

Kod	YHB Matkap Uçlu Vida	Koli Adedi	Ağırlık
Code	YHB Screws With Drill Ends	Quantity	Gross Weight
Код	YHB Саморезы, Потайная Головка	Количество	Вес
	d L		
V.YHB.01	3,9 X 13 YHB MUV	15,000	14,50 Kg
V.YHB.02	3,9 X 16 YHB MUV	15,000	17,20 Kg
V.YHB.03	3,9 X 19 YHB MUV	15,000	20,50 Kg
V.YHB.04	3,9 X 22 YHB MUV	12,000	18,40 Kg
V.YHB.05	3,9 X 25 YHB MUV	11,000	18,88 Kg
V.YHB.06	3,9 X 32 YHB MUV	10,000	21,60 Kg
V.YHB.07	3,9 X 38 YHB MUV	8,000	20,32 Kg
V.YHB.08	4,2 X 19 YHB MUV	15,000	22,90 Kg
V.YHB.09	4,2 X 22 YHB MUV	10,000	17,70 Kg
V.YHB.10	4,2 X 25 YHB MUV	10,000	18,90 Kg
V.YHB.11	4,2 X 32 YHB MUV	8,000	19,44 Kg
V.YHB.12	4,2 X 38 YHB MUV	6,000	17,14 Kg
V.YHB.13	4,2 X 45 YHB MUV	5,000	16,80 Kg
V.YHB.14	4,2 X 50 YHB MUV	5,000	18,40 Kg
V.YHB.15	4,8 X 25 YHB MUV	5,000	13,35 Kg
V.YHB.16	4,8 X 32 YHB MUV	5,000	16,30 Kg
V.YHB.17	4,8 X 38 YHB MUV	5,000	16,29 Kg
V.YHB.18	4,8 X 50 YHB MUV	4,000	20,16 Kg
V.YHB.19	4,8 X 60 YHB MUV	3,000	17,95 Kg
V.YHB.20	4,8 X 70 YHB MUV	2,000	13,98 Kg
V.YHB.21	4,8 X 80 YHB MUV	1,500	11,82 Kg
V.YHB.22	4,8 X 100 YHB MUV	1,200	11,38 Kg

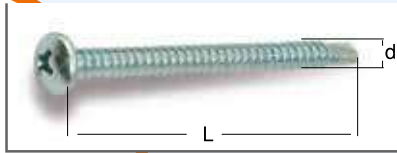

YSB

Kod	YSB Matkap Uçlu Vida	Koli Adedi	Ağırlık
Code	YSB Screws With Drill Ends	Quantity	Gross Weight
Код	YSB Саморезы, Цилиндрич. Головка	Количество	Вес
	d L		
V.YSB.01	3,9 X 13 YSB MUV	15,000	18,70 Kg
V.YSB.02	3,9 X 16 YSB MUV	15,000	21,40 Kg
V.YSB.03	3,9 X 19 YSB MUV	15,000	24,10 Kg
V.YSB.04	3,9 X 22 YSB MUV	13,000	23,41 Kg
V.YSB.05	4,8 X 16 YSB MUV	10,000	24,10 Kg
V.YSB.06	4,8 X 19 YSB MUV	8,000	22,00 Kg
V.YSB.07	4,8 X 25 YSB MUV	6,000	19,38 Kg
V.YSB.08	4,8 X 32 YSB MUV	5,000	19,30 Kg
V.YSB.09	4,8 X 38 YSB MUV	5,000	22,20 Kg
V.YSB.10	4,8 X 50 YSB MUV	3,000	16,84 Kg
V.YSB.11	4,8 X 60 YSB MUV	3,000	19,54 Kg
V.YSB.12	4,8 X 70 YSB MUV	2,000	12,84 Kg
V.YSB.13	4,8 X 80 YSB MUV	1,500	12,69 Kg
V.YSB.14	4,8 X 100 YSB MUV	1,200	11,38 Kg

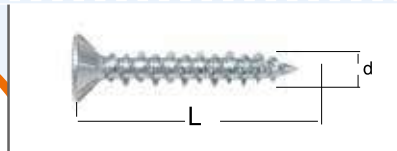

Kod	YHB Seyrek Dişli İspanyalet Vidası	Koli Adedi	Ağırlık
Code	YHB Seyrek Espagnolette Screws	Quantity	Gross Weight
Код	YHB Шурупы Вертикального Замка	Количество	Вес
	d L		
V.SEY.01	3,9 X 22 YHB SEYREK	15,000	19,90 Kg
V.SEY.02	3,9 X 25 YHB SEYREK	12,000	18,88 Kg
V.SEY.03	3,9 X 32 YHB SEYREK	10,000	18,80 Kg
V.SEY.04	3,9 X 38 YHB SEYREK	8,000	17,36 Kg
V.SEY.05	4,2 X 32 YHB SEYREK	8,000	17,84 Kg
V.SEY.06	4,2 X 38 YHB SEYREK	6,000	15,76 Kg
V.SEY.07	4,2 X 45 YHB SEYREK	5,000	15,40 Kg

Саморезы



Kod	YHB Sık Dişli Montaj Vidası	Koli Adedi	Ağırlık
Code	YHB Hinge Screws	Quantity	Gross Weight
Код	YHB Шурупы Для Петель, Резьба Частая	Количество	Вес
	d L		
V.MSD.01	4,2 X 32 YHB SIK DIŞ	12,000	30.35 KG
V.MSD.02	4,2 X 38 YHB SIK DIŞ	6,000	18.30 KG
V.MSD.03	4,2 X 45 YHB SIK DIŞ	6,000	20.60 KG



Kod	Buldeks Montaj Vidaları	Koli Adedi	Ağırlık
Code	Buldeks Montage Screws	Quantity	Gross Weight
Код	Монтажные Шурупы	Количество	Вес
V.TDR.01	7,5 X 60 TDR MONTAJ	1,500	16,50 KG
V.TDR.02	7,5 X 80 TDR MONTAJ	1,500	23,32 KG
V.TDR.03	7,5 X 100 TDR MONTAJ	1,000	19,37 KG
V.TDR.04	7,5 X 120 TDR MONTAJ	1,000	24,50 KG
V.TDR.05	7,5 X 150 TDR MONTAJ	800	14,13 KG

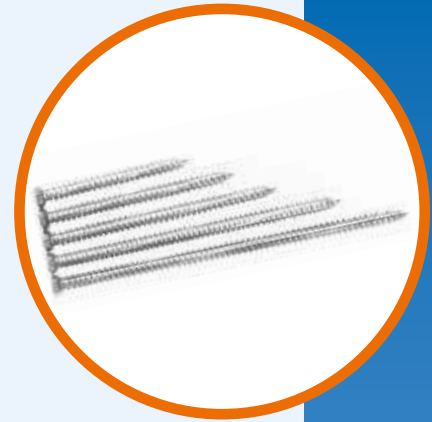

Kod	YSB Montaj Vidaları	Koli Adedi	Ağırlık
Code	YSB Montage Screws Without Anchors	Quantity	Gross Weight
Код	YSB Монтажные Шурупы	Количество	Вес
V.MNT.01	6 X 60 YSB MONTAJ	1,200	17,50 Kg
V.MNT.02	6 X 80 YSB MONTAJ	1,500	18,14 KG
V.MNT.03	6 X 100 YSB MONTAJ	1,200	18.62 KG
V.MNT.04	6 X 120 YSB MONTAJ	1,000	18,00 KG



Kod	Metrik Vida	Koli Adedi	Ağırlık
Code	Metrik Screws	Quantity	Gross Weight
Код	Метрические Винты	Количество	Вес
V.MET.01	M 6 X 50 YSB	2000	17,60 Kg
V.MET.02	M 6 X 60 YSB	1,500	18,45 Kg
V.MET.03	M 5 X 40 YHB	5,000	25,65 Kg
V.MET.04	M 5 X 45 YHB	4,000	23,00 Kg
V.MET.05	M 5 X 50 YHB	4,000	25,26 Kg
V.MET.06	M 5 X 60 YHB	3,000	17,10 Kg
V.MET.07	M 5 X 65 YHB	3,000	18,03 Kg
V.MET.08	M 5 X 70 YHB	2,500	15,80 Kg
V.MET.09	M 5 X 75 YHB	2,500	20,33 Kg
V.MET.10	M 5 X 80 YHB	2,000	19,88 Kg
V.MET.11	M 5 X 90 YHB	2,000	22,32 Kg



Наконечники



Kod Code Код	Ürün Adı Item Description Наименование Товара	Koli Adedi Quantity Количество	Ağırlık Gross Weight Вес
VUC.01	Hilti Ucu Bit Tip Наконечники Для Перфоратора	10	1.00 KG
VUC.02	Matkap Ucu 3 mm Drill Tip 3 mm Наконечники Для Дрели 3 мм	10	0.4 KG
VUC.03	Matkap Ucu 3.5 mm Drill Tip 3,5 mm Наконечники Для Дрели 3,5 мм	10	0.5 KG
VUC.04	Matkap Ucu 4 mm Drill Tip 4 mm Наконечники Для Дрели 4 мм	10	0.6 KG
VUC.05	Matkap Ucu 4.5 mm Drill Tip 4,5 mm Наконечники Для Дрели 4,5 мм	10	0.7 KG
VUC.06	Matkap Ucu 5 mm Drill Tip 5 mm Наконечники Для Дрели 5 мм	10	0.8 KG
VUC.06	Matkap Ucu 5 mm Drill Tip 5 mm Наконечники Для Дрели 5 мм	10	0.9 KG
VUC.07	Matkap Ucu 5.5 mm Drill Tip 5,5 mm Наконечники Для Дрели 5.5 мм	10	1 KG
VUC.08	Matkap Ucu 6 mm Drill Tip 6 mm Наконечник Фрезерный 6 мм	10	1.2 KG
VUC.09	Su Tahliye Freze Ucu Milling Tip Наконечники Фреза	10	1.00 KG
VUC.10	Köse Temizleme Viz Viz Uç Corner Cleaner Tip Наконечник Для Зачистки Углов	10	0.50 KG
VUC.11	PH 2x25 Yıldız Uç PH 2x25 Star Tip PH 2x25 Наконечники Звездный	10	0.80 KG
VUC.12	PH 2x50 Yıldız Uç PH 2x50 Star Tip PH 2x50 Наконечники Звездный	10	1 KG
VUC.13	PH 2x75 Yıldız Uç PH 2x75 Star Tip PH 2x75 Наконечники Звездный	10	1.2 KG
VUC.14	Manyetik Vidalama Adaptörü Screwdriver Adaptor Наконечники Отверточный	10	1 KG
VUC.15	5x80 mm Freze Ucu 5x80 Milling Tip 5x80 Наконечник Фрезерный	10	1 KG
VUC.16	T30x50 Tork Ucu T30x50 Torq Tip T30x50 Torq	10	0.60 KG
VUC.17	T30x75 Tork Ucu T30x75 Torq Tip T30x75 Torq	10	0.750 KG

Монтажные Материалы Для Стекла.

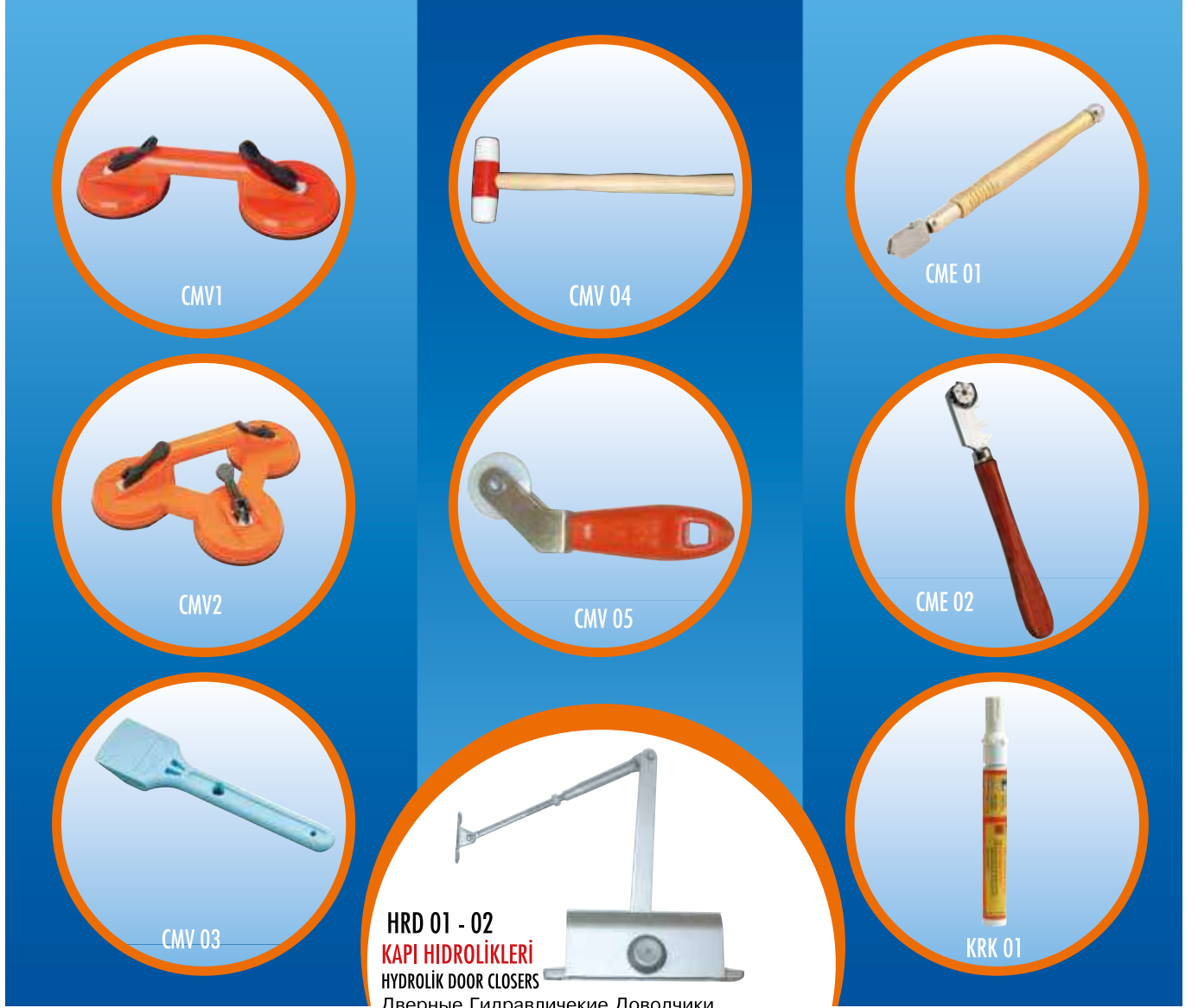

HRD 01 - 02
KAPI HIDROLİKLERİ
HYDROLİK DOOR CLOSERS
 Дверные Гидравлические Доводчики

Kod Code Код	Ürün Adı Item Description Наименование Товара	Koli Adedi Quantity Количество	Ağırlık Gross Weight Вес	Kod Code Код	Ürün Adı Item Description Наименование Товара	Koli Adedi Quantity Количество	Ağırlık Gross Weight Вес
CME 01	Cam Kesme Elması Glass Cutter Алмаз Стеклорез	1	0,035 Kg	CMV 04	Plastik Tokmak Plastik Beater Пластиковая Киянка	1	0,32 Kg
CME 02	Cam Kesme Elması Gazlı Glass Cutter with Gas Алмаз Стеклорез с Газом	1	0,047 Kg	CMV 05	Conta Çekme Makarası Gasket Roller Ролик Для Уплетнителя	1	0,050 Kg
CMV 01	Cam Vantuzu 2'li Double Air-Valve Двойной Вантуз	1	2 Kg	KRK 01	Köşe Rötüş Kalemi Colour Edging Pen Карандаш	1	0,020 Kg
CMV 02	Cam Vantuzu 3'lü Triple Air-Valve Тройной Вантуз	1	2,5 Kg	HRD 01	Kapı Hidroliği 3 numara Hydraulic Door Closer number 3 Дверной Гидравлический Доводчик Номер 3	10	17,5 Kg
CMV 03	Cam Kaldırma Küreği Glass Shovel Лопотка Для Регулирования Стекла	1	0,130 Kg	HRD 02	Kapı Hidroliği 4 numara Hydraulic Door Closer number 4 Дверной Гидравлический Доводчик Номер 4	10	22,7 Kg

SUPER KUTU

SUPER BOX

Lamel Yüksekliği Lamella	Ağırlığı Weight Kg/m ²	Azami Genişlik Max. Length	Azami Yükseklik Max. Height	Boru Çapı Oct. Profile	Super Kutu Kapasitesi Super Box Capacity 165x174
37	2,5	2,5	2,50	40 60	2,20 2,20
39	2,5	2,5	2,60	40 60	2,20 2,20
41	2,98	2,7	2,60	40 60	1,70 1,75
43	2,46	2,8	2,70	40 60	1,70 1,75
45	2,71	2,8	2,80	40 60	1,70 1,75
56	2,97	3,0	2,20	60 70	1,40 1,40

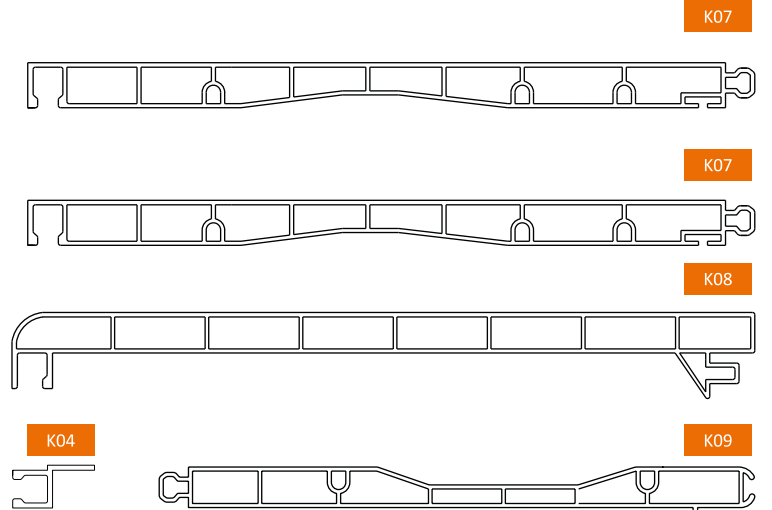
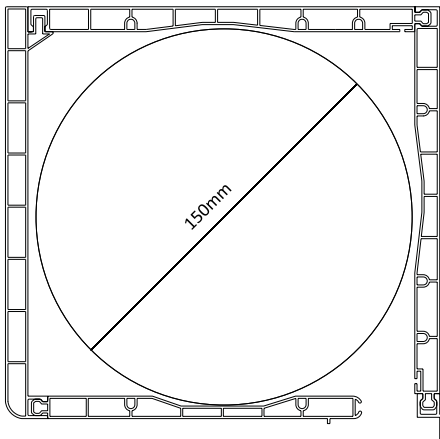
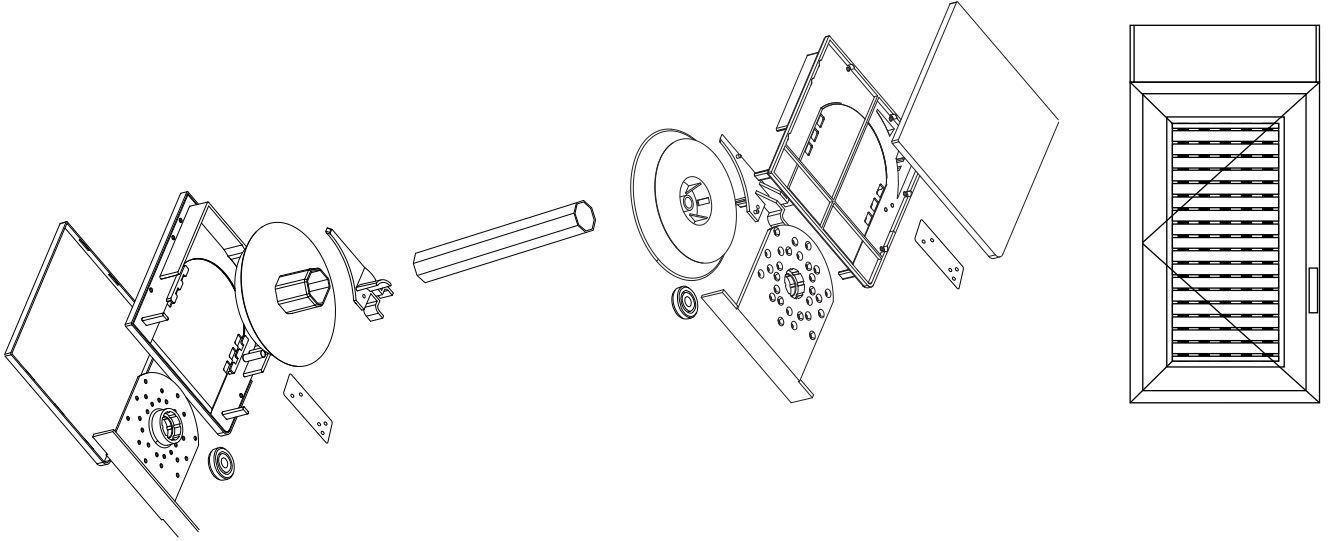

GROSS KUTU

GROSS BOX

Lamel Yüksekliği Lamella	Ağırlığı Weight Kg/m ²	Azami Genişlik Max. Length	Azami Yükseklik Max. Height	Boru Çapı Oct. Profile	Gros Kutu Kapasitesi Gros Box Capacity 175x175
37	2,5	2,5	2,50	40 60	2,75 2,75
39	2,5	2,5	2,60	40 60	2,75 2,75
41	2,98	2,7	2,60	40 60	2,25 2,00
43	2,46	2,8	2,70	40 60	3,00 3,00
45	2,71	2,8	2,80	40 60	2,25 2,00
55	3,6	3,5	3,00	60 70	1,50 1,50
55 GROSS	2,69	3	2,70	60 70	2,00 1,75
56	2,97	3,5	2,70	60 70	2,00 2,00

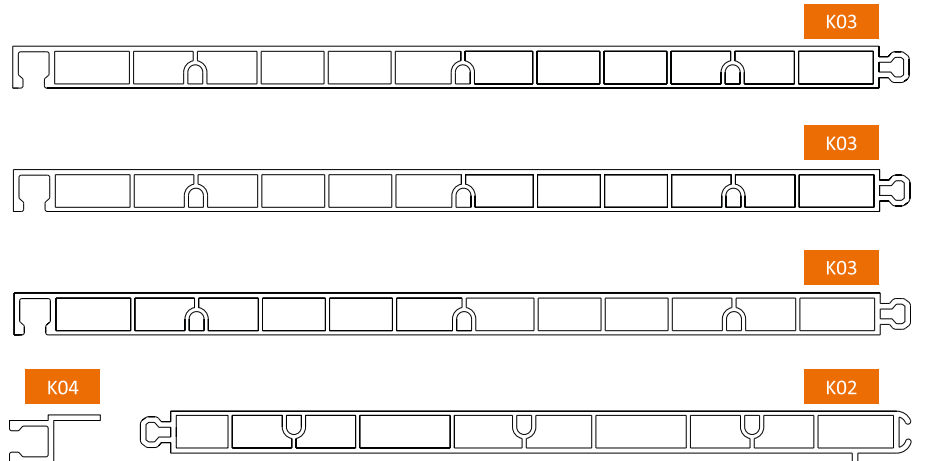
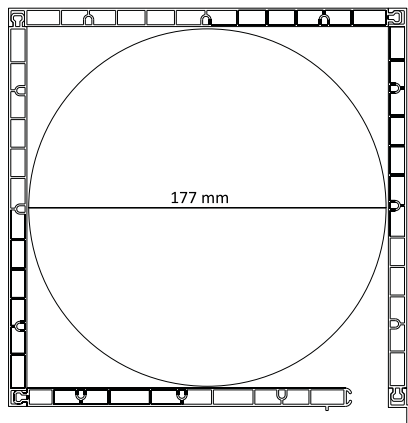
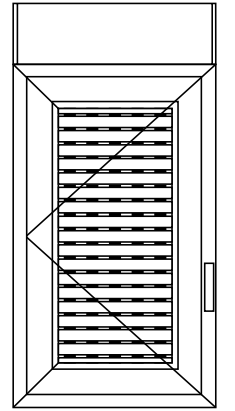
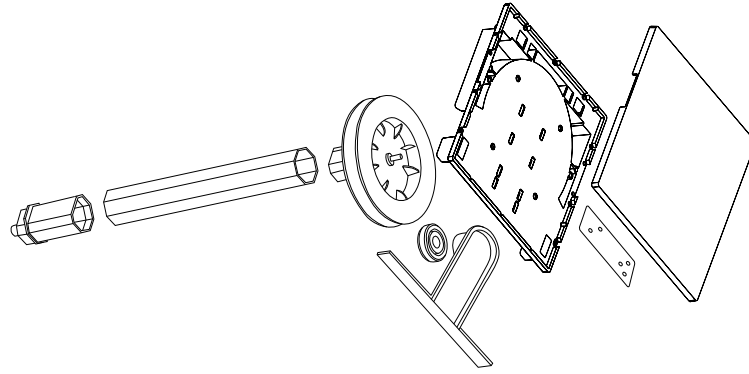
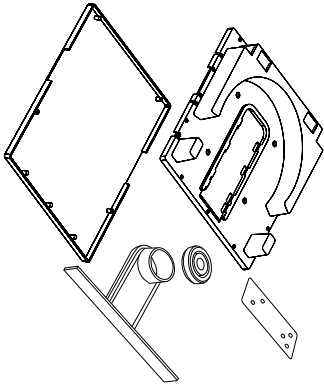

DİVA KUTU

DİVA BOX

Lamel Yüksekliği Lamella	Ağırlığı Weight Kg/m ²	Azami Genişlik Max. Length	Azami Yükseklik Max. Height	Boru Çapı Oct. Profile	Divla Kutu Kapasitesi Divla Box Capacity 207x207mm
37	2,5	2,5	2,50	40 60	4,50 4,50
39	2,5	2,5	2,60	40 60	4,40 4,40
41	2,98	2,7	2,60	40 60	3,30 3,30
43	2,46	2,8	2,70	40 60	3,50 3,40
45	2,71	2,8	2,80	40 60	3,30 3,30
55	3,6	3,5	3,00	60 70	2,60 2,60
55 GROSS	2,69	3	2,70	60 70	2,75 2,75
56	2,97	3,5	2,70	60 70	2,75 2,60

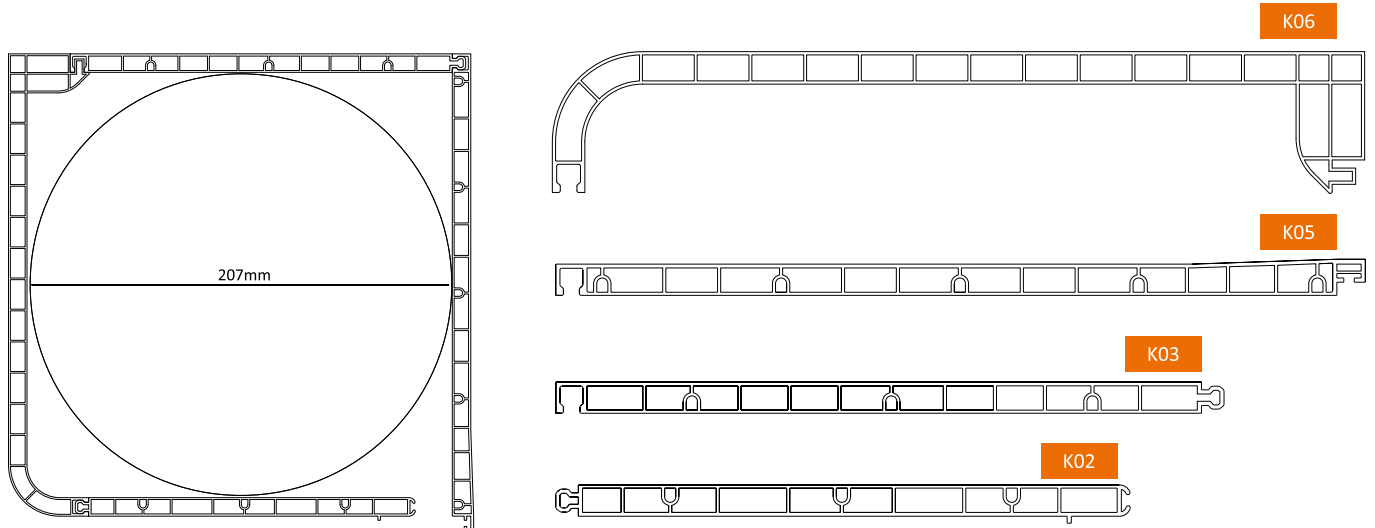
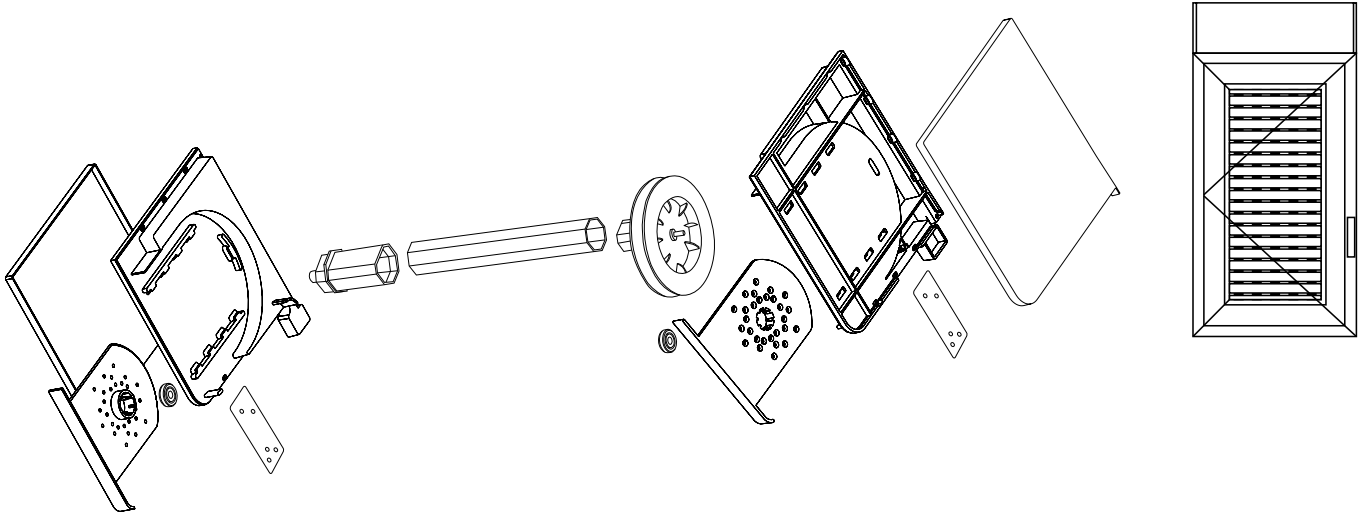
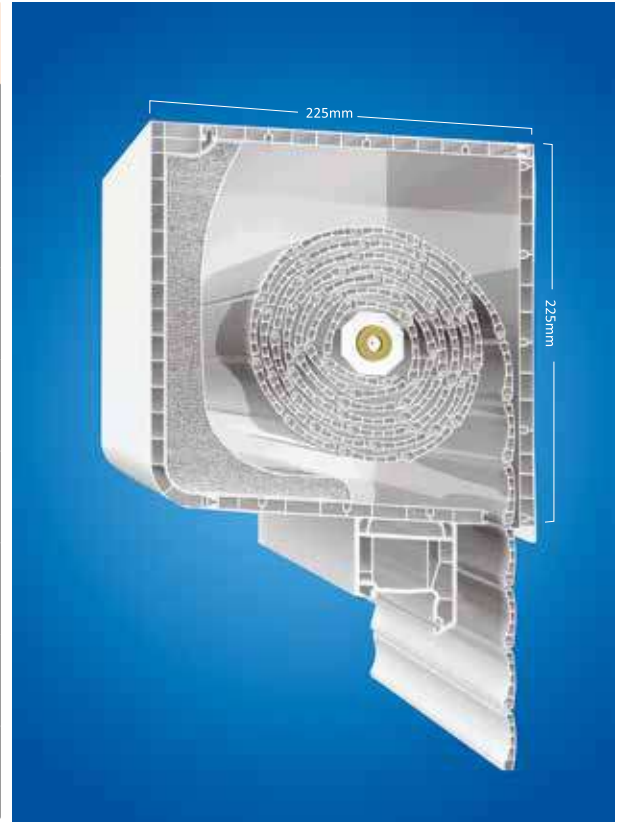

MEGA KUTU

MEGA BOX

Lamel Yüksekliği Lamella	Ağırlığı Weight Kg/m ²	Azami Genişlik Max. Length	Azami Yükseklik Max. Height	Boru Çapı Oct. Profile	Mega Kutu Kapasitesi Mega Box Capacity 175x175 mm
37	2,5	2,5	2,50	40 60	2,75 2,75
39	2,5	2,5	2,60	40 60	2,75 2,75
41	2,98	2,7	2,60	40 60	2,25 2,00
43	2,46	2,8	2,70	40 60	3,00 3,00
45	2,71	2,8	2,80	40 60	2,25 2,00
55	3,6	3,5	3,00	60 70	1,50 1,50
55 GROSS	2,69	3	2,70	60 70	2,00 1,75
56	2,97	3,5	2,70	60 70	2,00 2,00

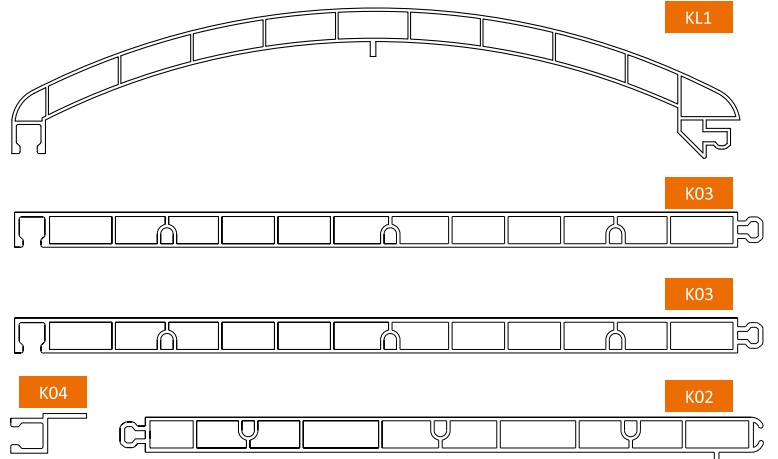
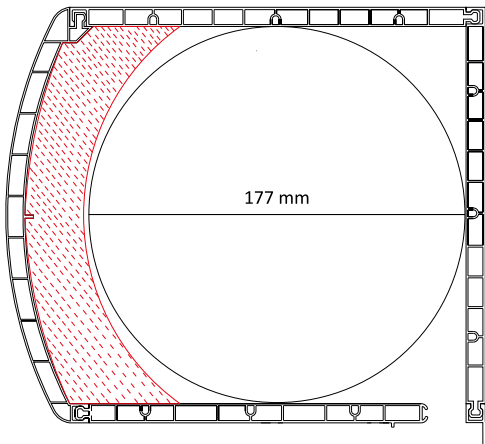
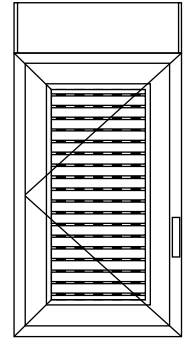
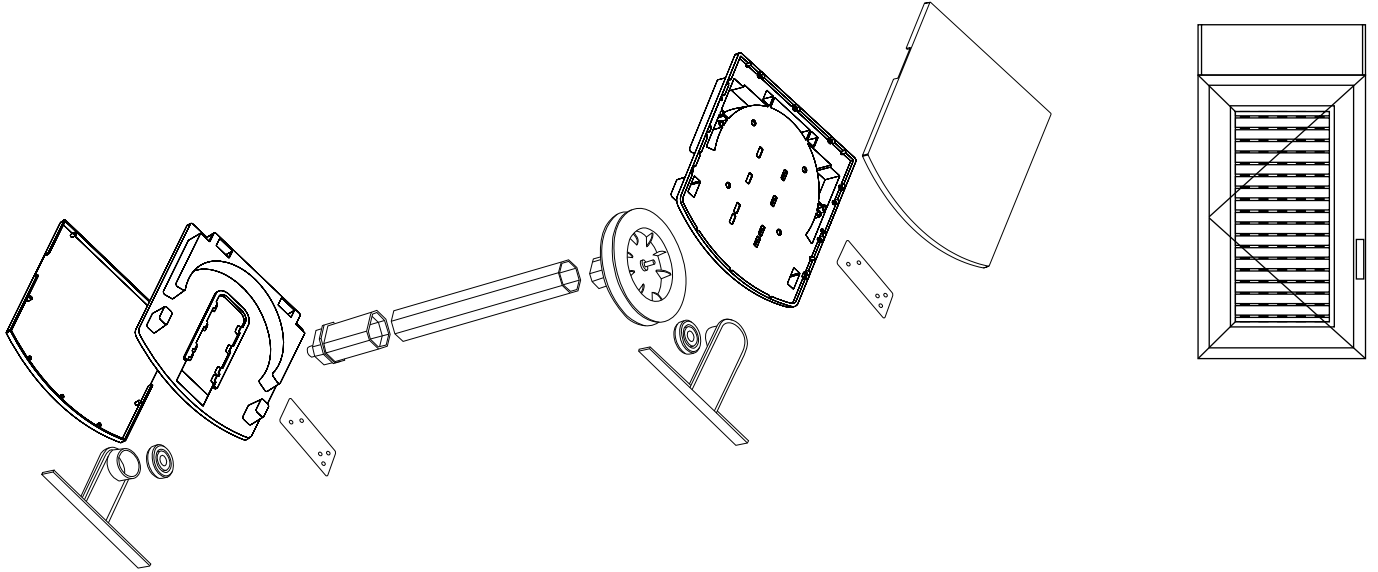

YAN KAPAK SETİ SUPER / FLANK COVER SET SUPER

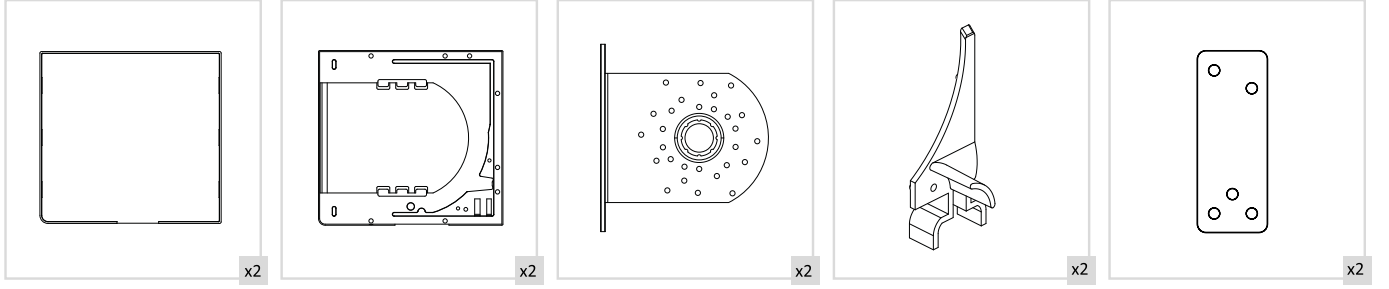

ORTA BÖLME SETİ SUPER / MIDDLE COVER SET SUPER

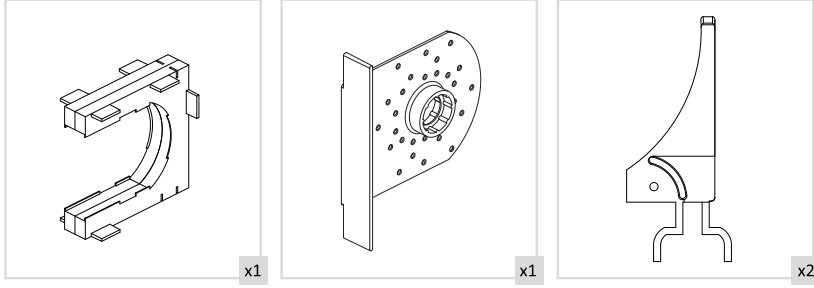

YAN KAPAK SETİ GROSS/ FLANK COVER SET GROSS

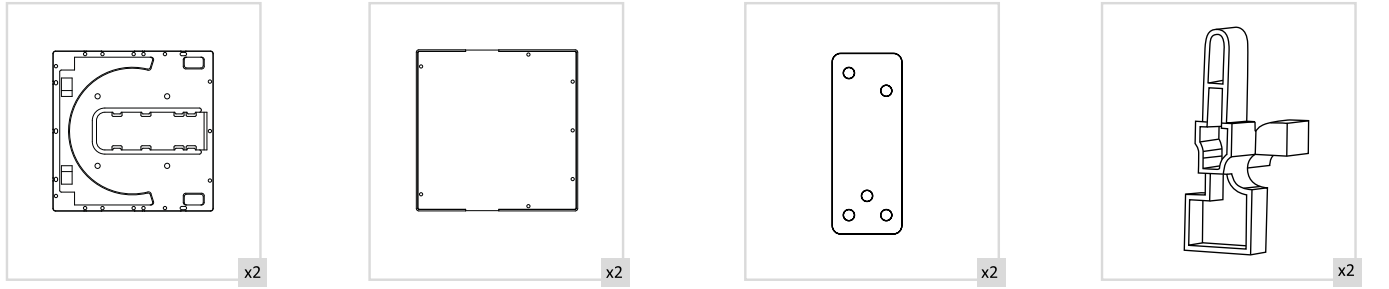

YAN KAPAK SETİ DIVA/ FLANK COVER SET DIVA

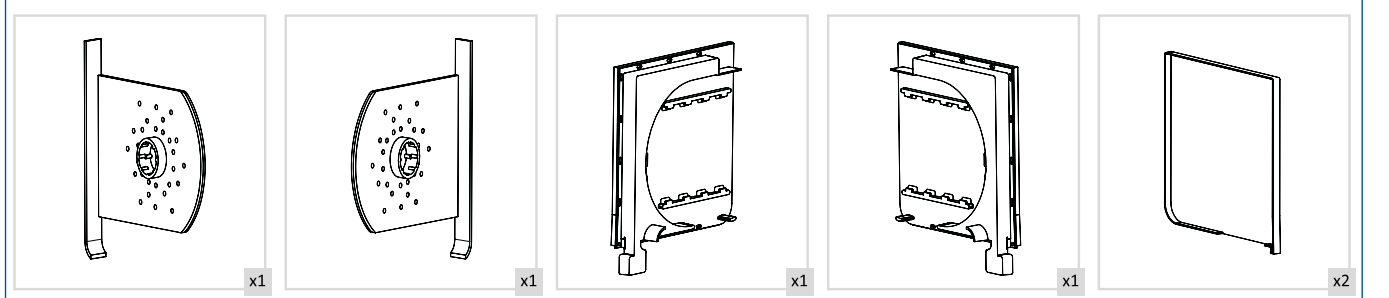

ORTA BÖLME SETİ / MIDDLE COVER SET

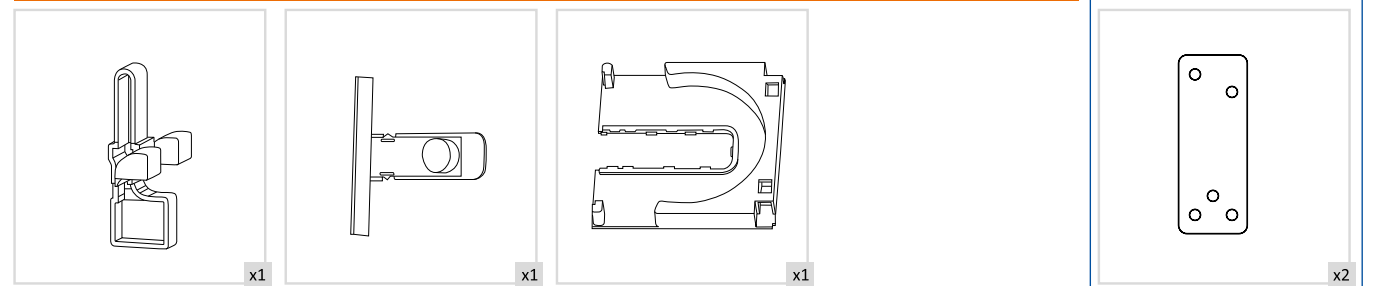

YAN KAPAK SETİ MEGA / FLANK COVER SET MEGA

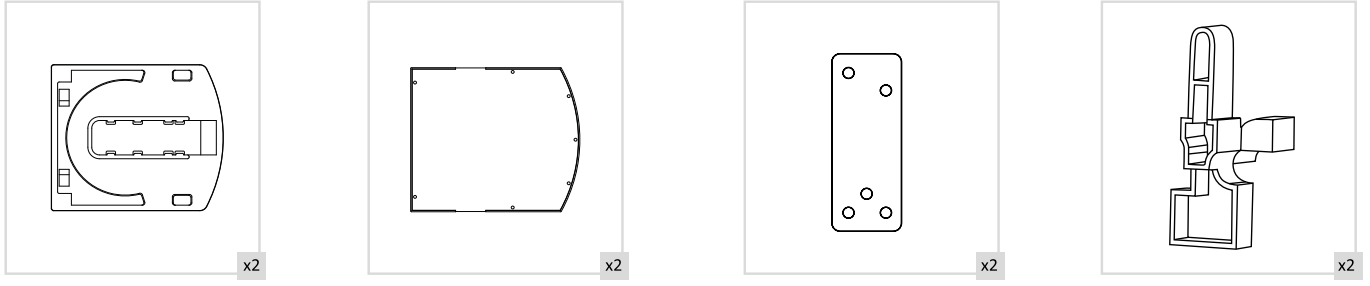

K304000
K306000

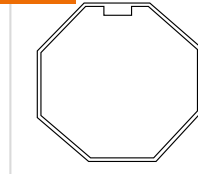

KA60000
KA60505



K214000
K226000

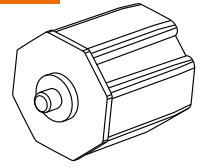

AKSESUARLAR / ACCESSORIES

K230000
K230505



K204000

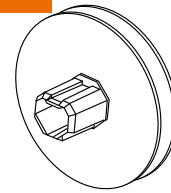

K326000

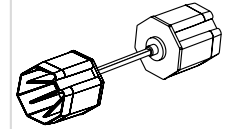

K290000

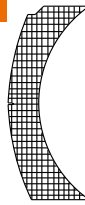

K01000P



K31000P



YAN & ORTA RAY PROFİLLERİ
FLANK & MIDDLE LINE PROFILES

KD6

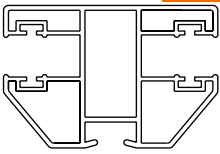

KG6

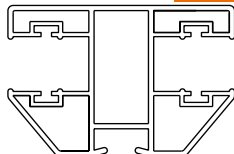

KG5

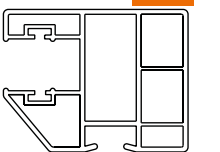

KL3

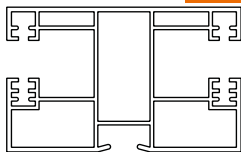

KL2

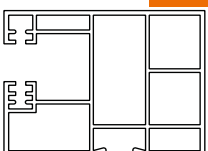

KD5

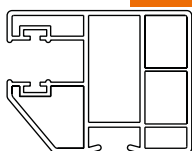

K240000
K240505

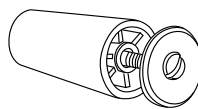

K310037
K310050
K310055

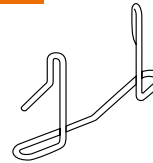

K260000



K280000
K280001

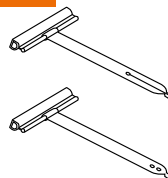

K250000
K250505

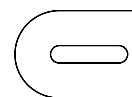

K276760

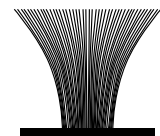

K320000

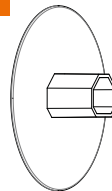

K330000

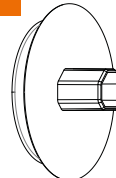

K340000

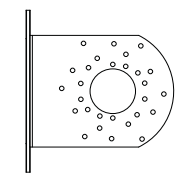



YAPI İNŞAAT SANAYİ VE TİCARET LIMITED ŞİRKETİ.

Baskı Tarihi : 11 Mart 2016
Dizayn Reklam ve Matbaacılık / Turhan AVCI
Tel : 0212. 567 28 29



www.kosgeb.gov.tr
Bu materyal 11 Mart 2016 tarihinde
2000 adet KOSGEB desteğiyle bastırılmıştır.

Donanmacı Mah. 1721 Sk. No.4/109
Karşıyaka - İzmir / TURKEY

Gsm : 0090 543 231 66 25
Tel : 0090 232 323 00 44

info@amsgroup.com.tr

www.amsgroup.com.tr